

Methods of signal processing and cosmic muon calibration for the BM@N and CBM sampling lead/scintillator hadron calorimeters

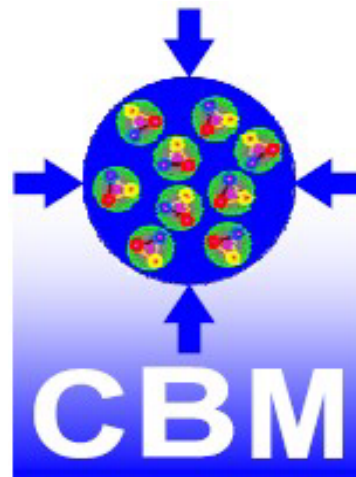

Sergey Morozov on behalf of INR RAS, Moscow



Sampling hadron calorimeters in heavy ion experiments

NA61@SPS

Start of operation after upgrade - 2021

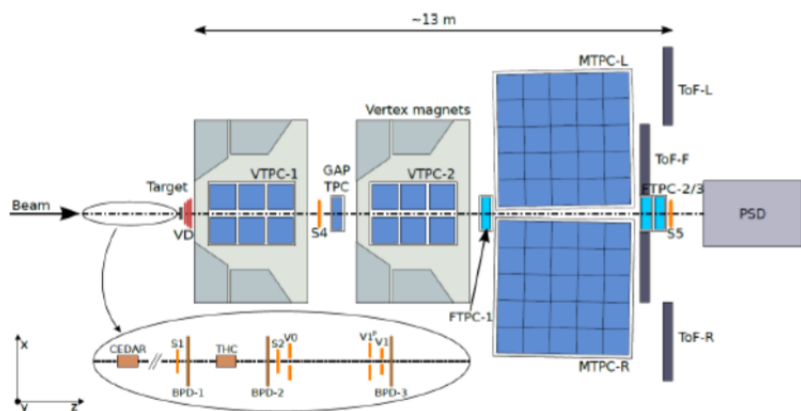

BM@N

Start of operation after upgrade - 2020

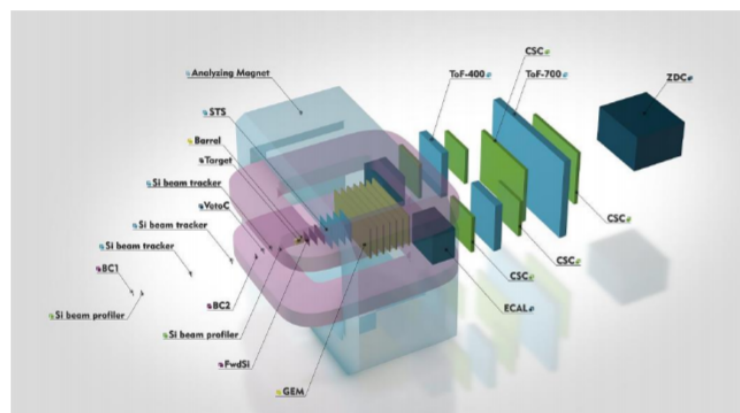

CBM@FAIR

Start of experiments at FAIR - 2024

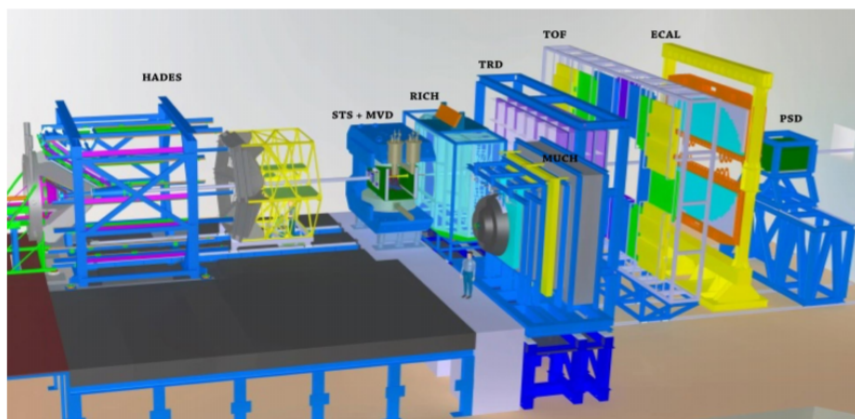

Number of interacting participants in collision:

$$N = A - E_s / E_a$$

A – mass number of ion

E_a – beam energy per nucleon (known from accelerator)

E_s – energy carried by the non-interacting nucleons (projectile spectators) - **measured with PSD**

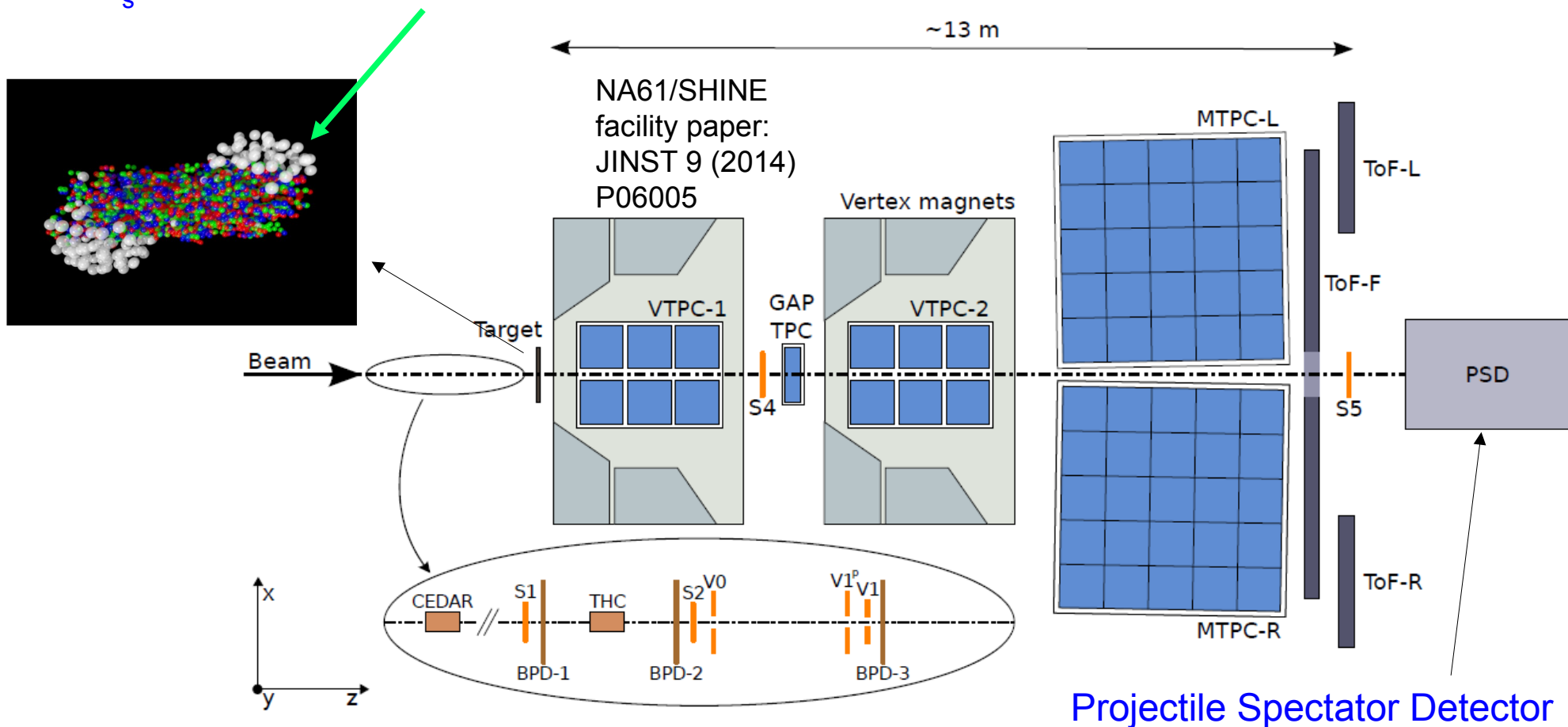

Sampling hadron calorimeter (PSD)
on NA61/SHINE beam line
CERN, SPS

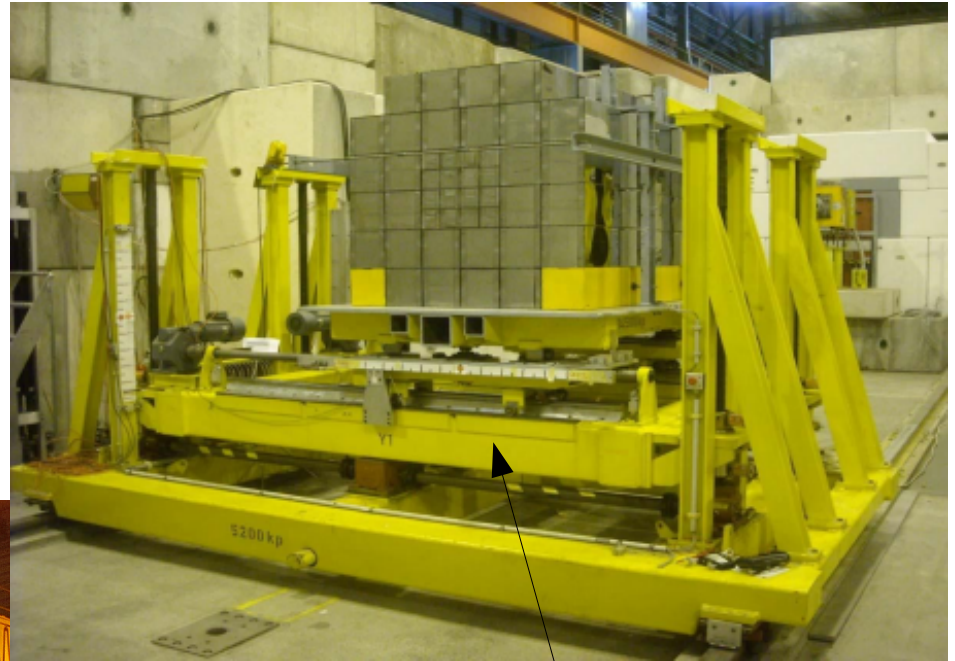

Moving platform

- move PSD according to magnetic field
- calibration of each module on muon beam



PSD module

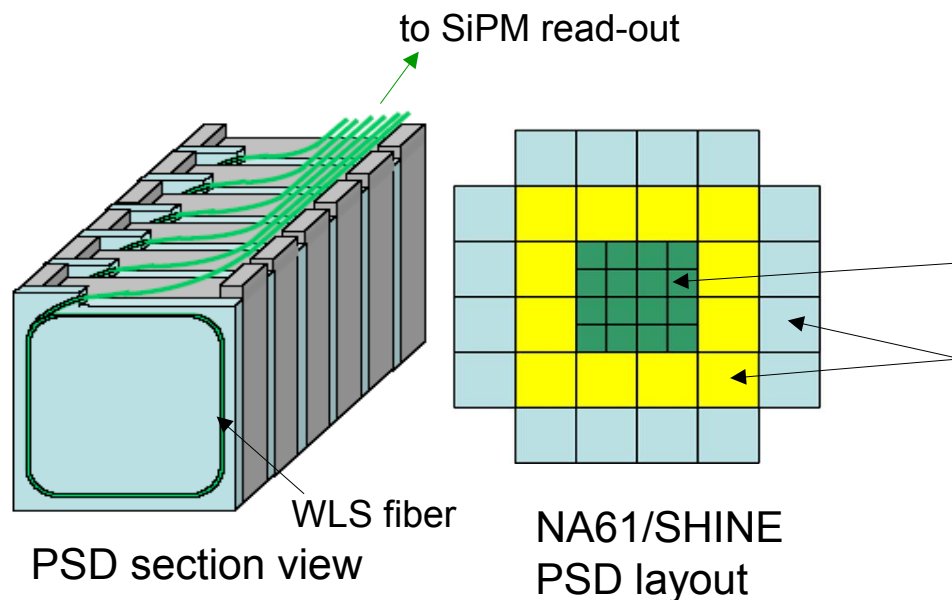

PSD is a hadron sampling compensating calorimeter

- Pb/scintillator (4/1) 60 sandwiches in one module
- Modules $10 \times 10 \times 120 \text{ cm}^3$ – central part
- Modules $20 \times 20 \times 120 \text{ cm}^3$ – outer part
- 10 longitudinal sections with 10 SiPM readout

Muon calibrations:

- at NA61/SHINE: direct measurements with moving calorimeter moduled to the beam center
- at T9/T10 beam tests: moving platform + setting trigger counters in front of the module under calibration
- BM@N, CBM → no direct mouns expected from accelerator, we need to use another approach

Front-End-Electronics:

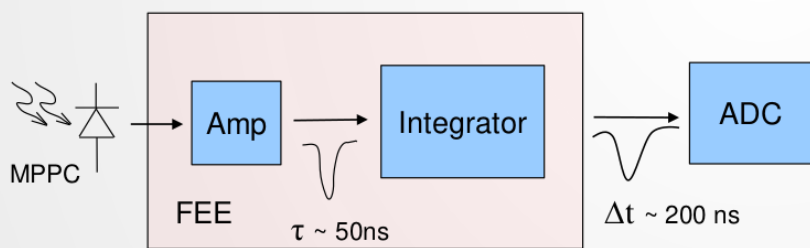
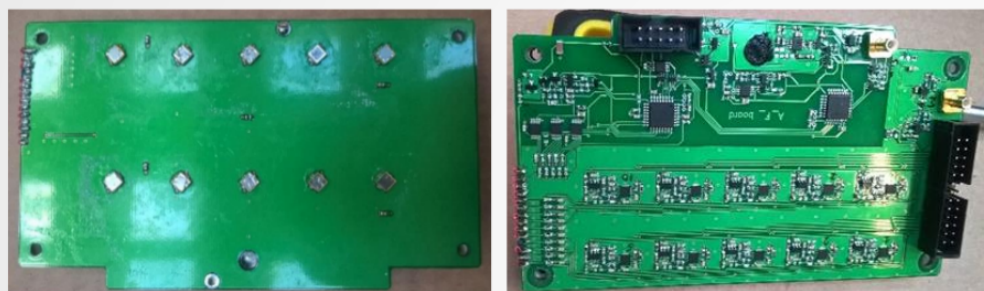

waveform \rightarrow apply fit

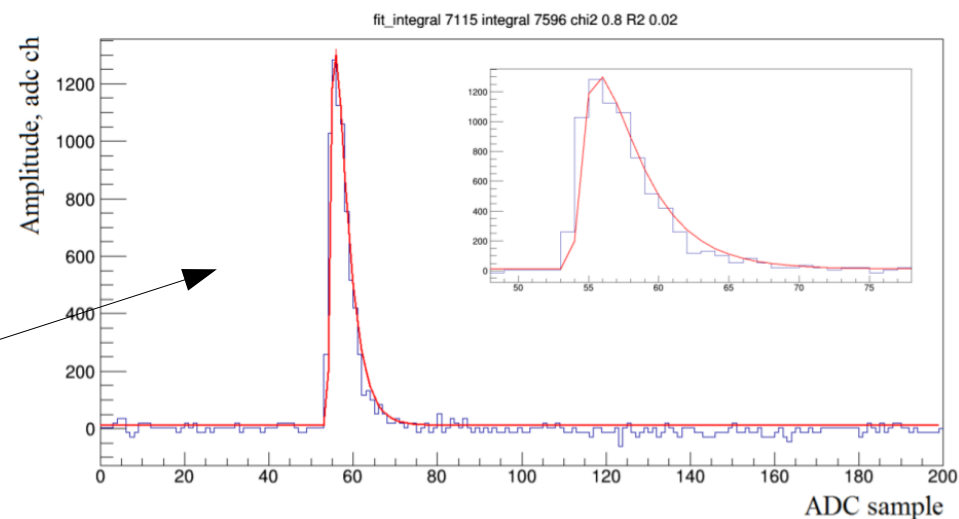

Fitting procedure advantage for moun calibration:

- more correct determination of amplitude and charge
- working with small signals near the noise level
- interference and pile-up identification
- true signal recovery



BM@N Readout electronics:
FPGA based 64 channel ADC64 board,
62.5MS/s (AFI Electronics, JINR, Dubna).

Prony Least Squares method

Allows to estimate a set of complex data samples $x[n]$ using the p -term model of exponential components:

$$\hat{x}[n] = \sum_{k=1}^p A_k \exp[(\alpha_k + j2\pi f_k)(n-1)T + j\theta_k] = \sum_{k=1}^p h_k z_k^{n-1}$$

$n = 1, 2, \dots, N$, $j^2 = -1$, T – sampling interval. $\mathbf{h}_k = A_k \exp(j\theta_k)$, $\mathbf{z}_k = \exp[(\alpha_k + j2\pi f_k)T]$.

Objects of estimation are: amplitudes of complex exponentials A_k , attenuation parameters α_k , harmonic frequencies f_k and phases θ_k .

3 algorithm steps:

1. Composing and solving SLE $p \times p$ } \mathbf{z}_k
2. Polynomial factorization
3. Composing and solving SLE $(p+1) \times (p+1)$ $\longrightarrow \mathbf{h}_k$

3 orders of magnitude faster than MINUIT

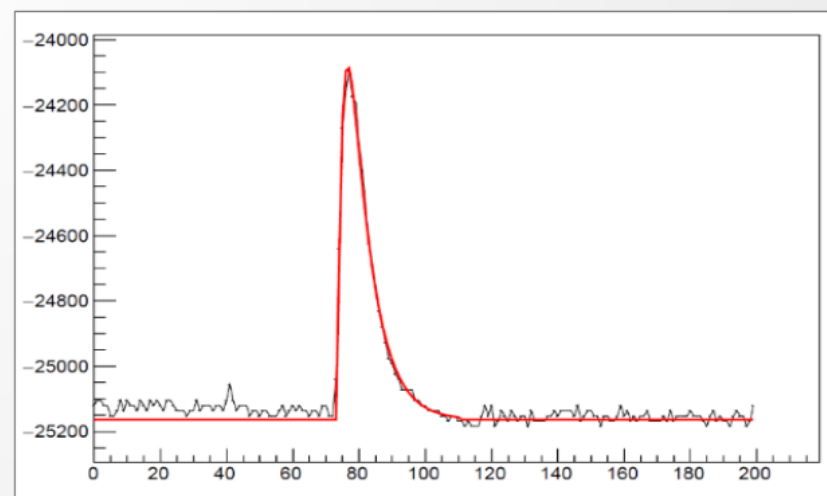

Fit quality assessment

15

Determination coefficient*

$$R^2 = \frac{\sum_{n=1}^N (x[n] - \hat{x}[n])^2}{\sum_{n=1}^N (x[n] - \bar{x})^2}$$

$x[n]$ and $\hat{x}[n]$ are the experimental and model values of the variable, respectively. \bar{x} is the experimental values average.

Adjusted determination coefficient*

$$R_{adj}^2 = R^2 \frac{N - 1}{N - \lambda}$$

N is the number of measurements, λ is the number of model parameters.

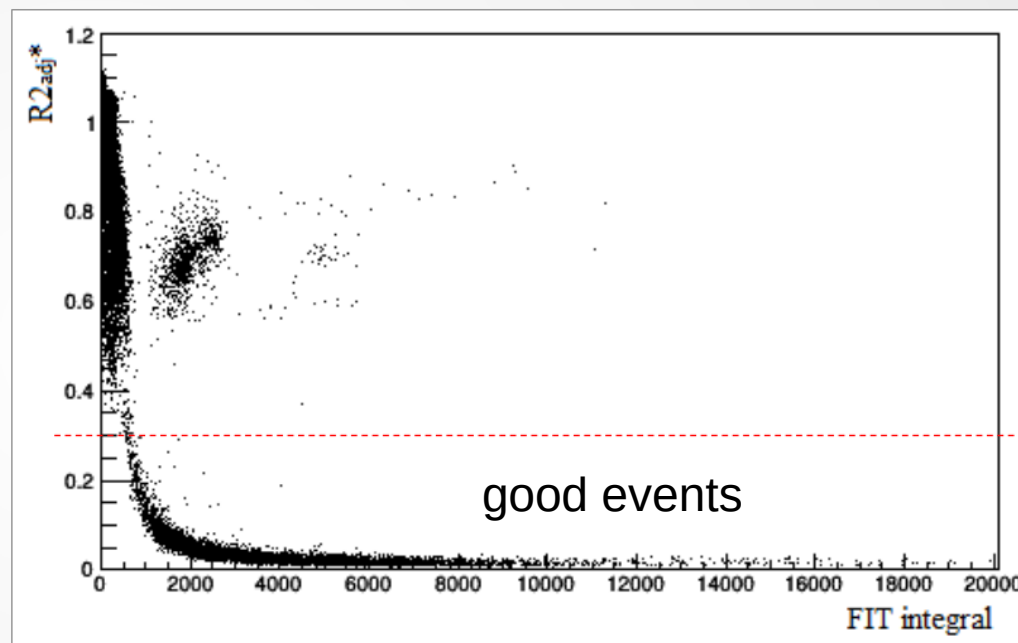

Pileup rejection

17

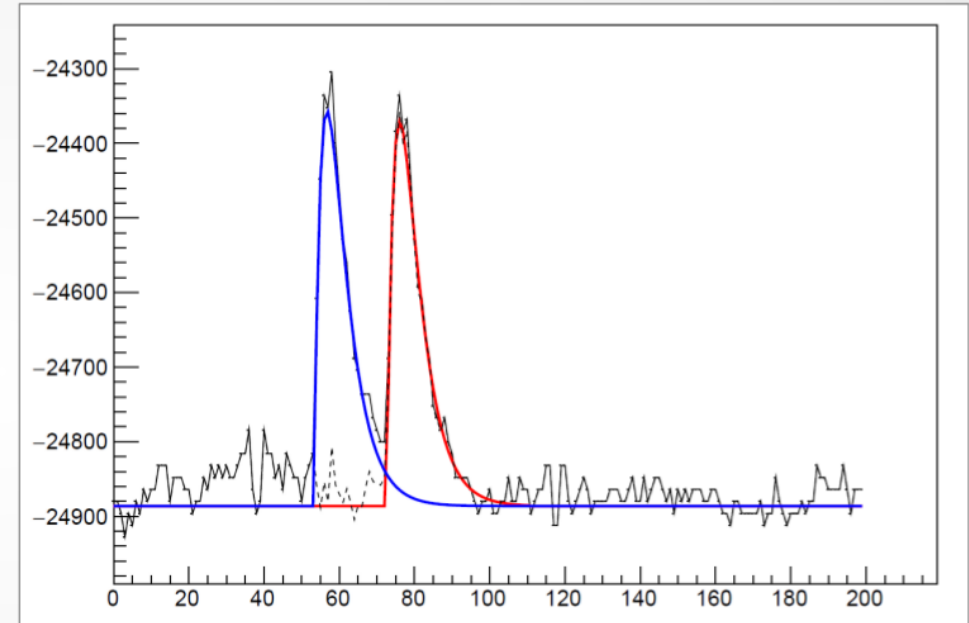
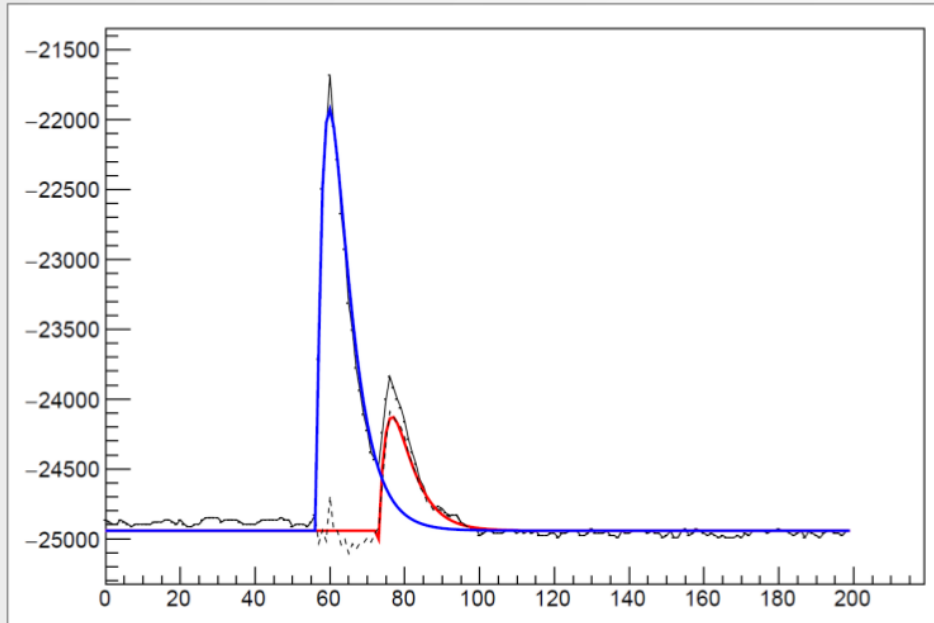

- ❖ Minimum distance between the pileup and the true signal \geq length of the leading edge
- ❖ Edge sensitive digital filter
- ❖ Pileup rejection and the true signal recovery

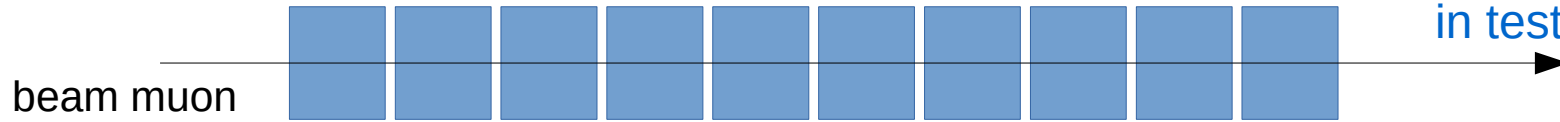

Identification of muons – equal energy deposition in first and last half of modules.

**Muons deposit
~5 MeV
in one section**

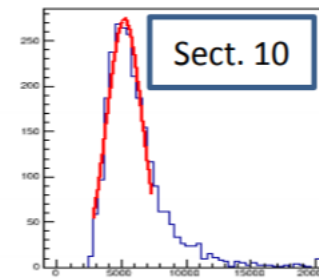
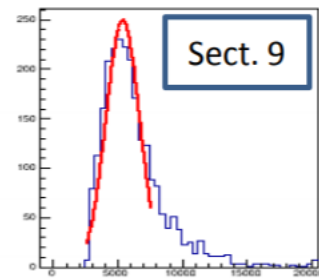
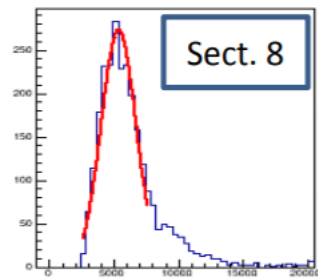
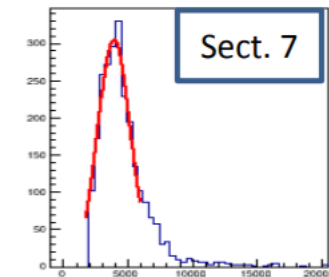
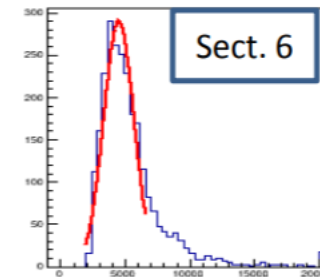
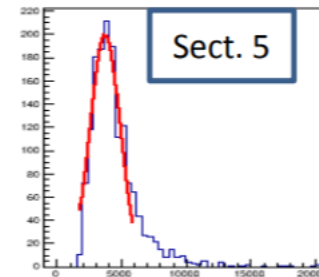
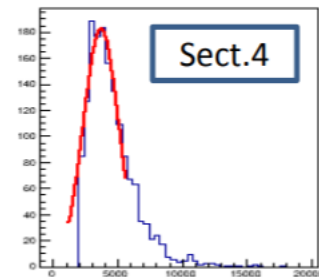
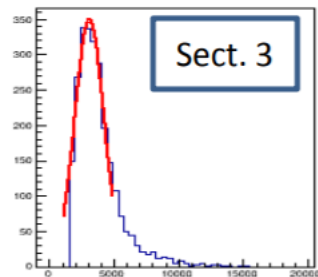
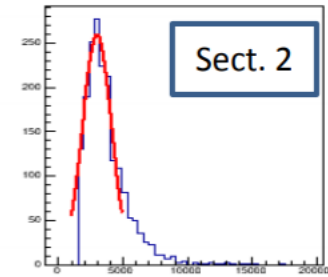
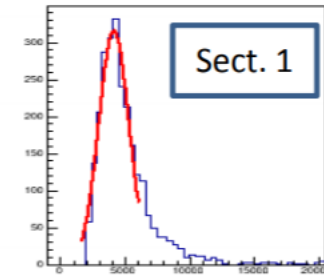
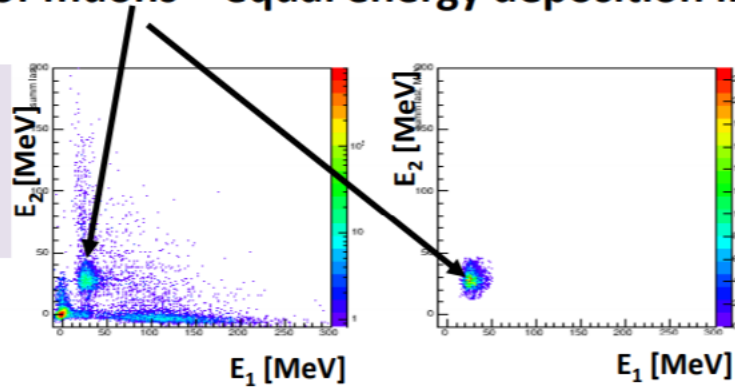

**Muons energy deposition
spectra in 10 sections
of central module.**



Types of cosmic muon identifications in longitudinal segmentation of PSD module

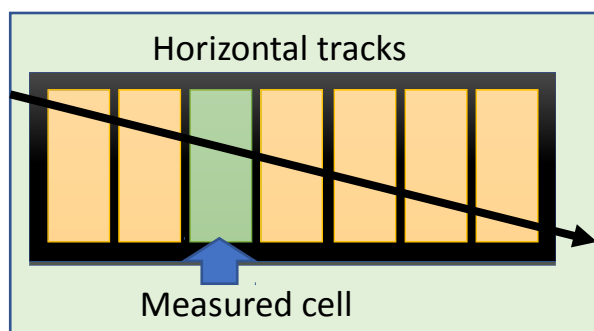

too low statistics

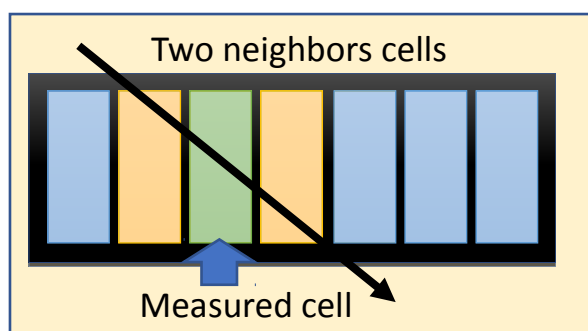

not good for cells at edges

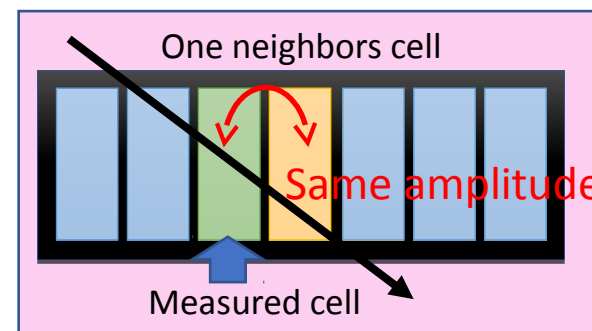

too much noise

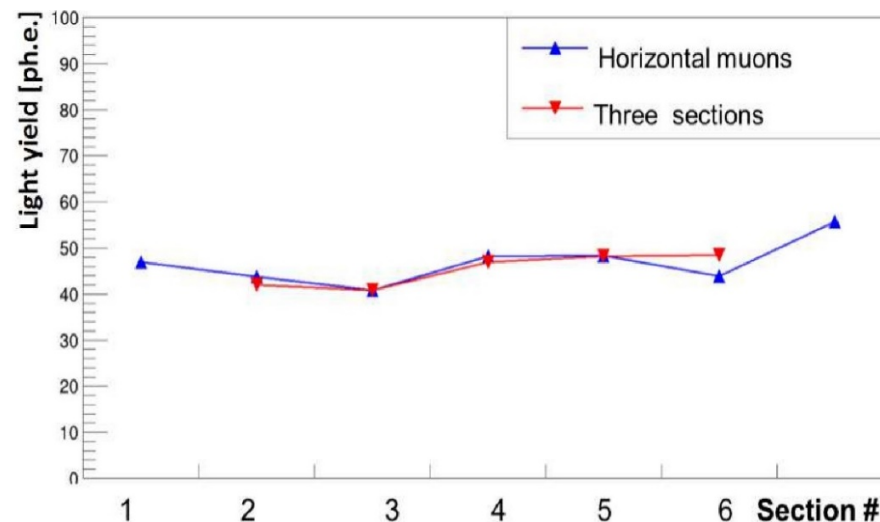
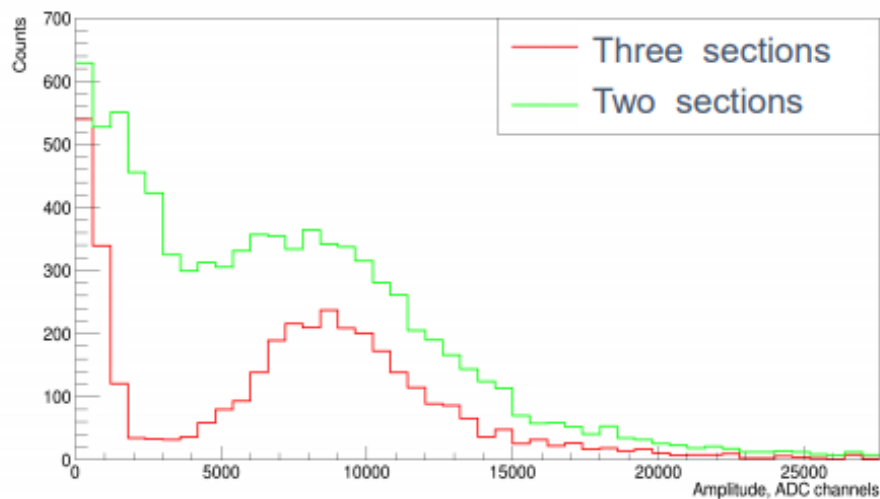

..more smart solution is needed

New muon calibration approach

18

Cosmic muons deposit different amounts of energy in the calorimeter sections depending on the position and direction of the particle track. This should be taken into account when conducting a muon calibration.

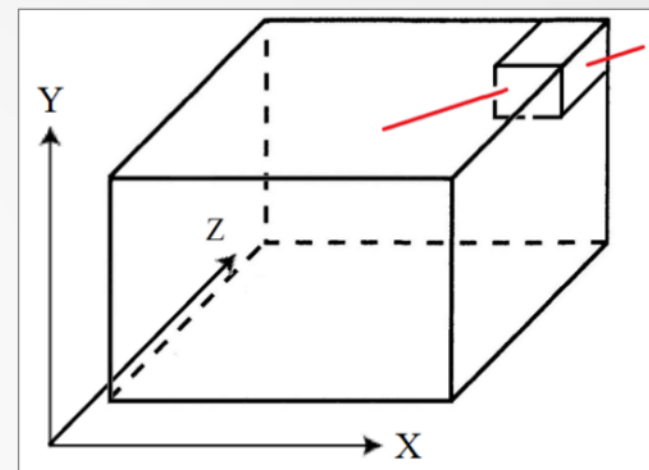

Calibration approach:

- ❖ Reconstruct muon tracks using signals selected with fit QA
- ❖ Determine the thickness of the scintillator passed by track in each cell
- ❖ Make corrections when calculating energy deposition

Muon track reconstruction

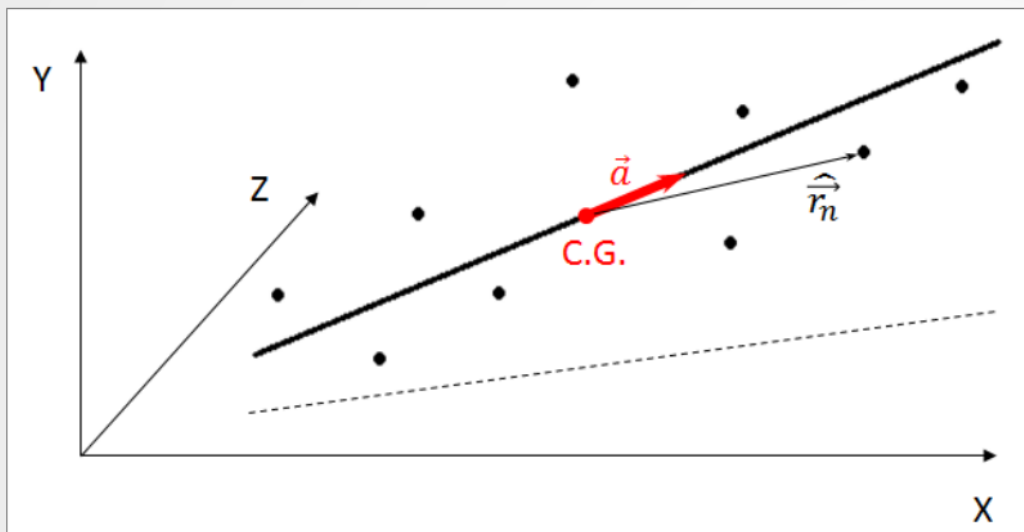

- ❖ Selection of triggered sections by fit QA
- ❖ Shift reference system to the center of gravity

$$\vec{R}_{C.G.} = \frac{1}{N} \sum_{n=1}^N E[n] \vec{r}[n].$$

- ❖ Extremum search

$$\sum_{n=1}^N \left(\hat{r}^2[n] - \left(\frac{(\hat{r}[n], \vec{a})}{|\vec{a}|} \right)^2 \right) \rightarrow \min$$

$$\sum_{n=1}^N \left(\frac{(\hat{r}[n], \vec{a})}{|\vec{a}|} \right)^2 \rightarrow \max \quad \varphi = \sum_{n=1}^N \hat{r}_i a_i \hat{r}_j a_j \rightarrow \max$$

Maximizing the quadratic form φ on the unit vector \vec{a} . The quadratic form is maximal on the eigenvector corresponding to the maximal eigenvalue.

$$M = \begin{pmatrix} \sum_{n=1}^N r_n^x r_n^x & \sum_{n=1}^N r_n^x r_n^y & \sum_{n=1}^N r_n^x r_n^z \\ \sum_{n=1}^N r_n^y r_n^x & \sum_{n=1}^N r_n^y r_n^y & \sum_{n=1}^N r_n^y r_n^z \\ \sum_{n=1}^N r_n^x r_n^z & \sum_{n=1}^N r_n^y r_n^z & \sum_{n=1}^N r_n^z r_n^z \end{pmatrix}$$

..segmented calorimeter is a “moun tracker” now..

Adjusted charge calculation

20

Calculation of the thickness of scintillator material traversed by the particle track by enumerating 6 faces of each triggered section.

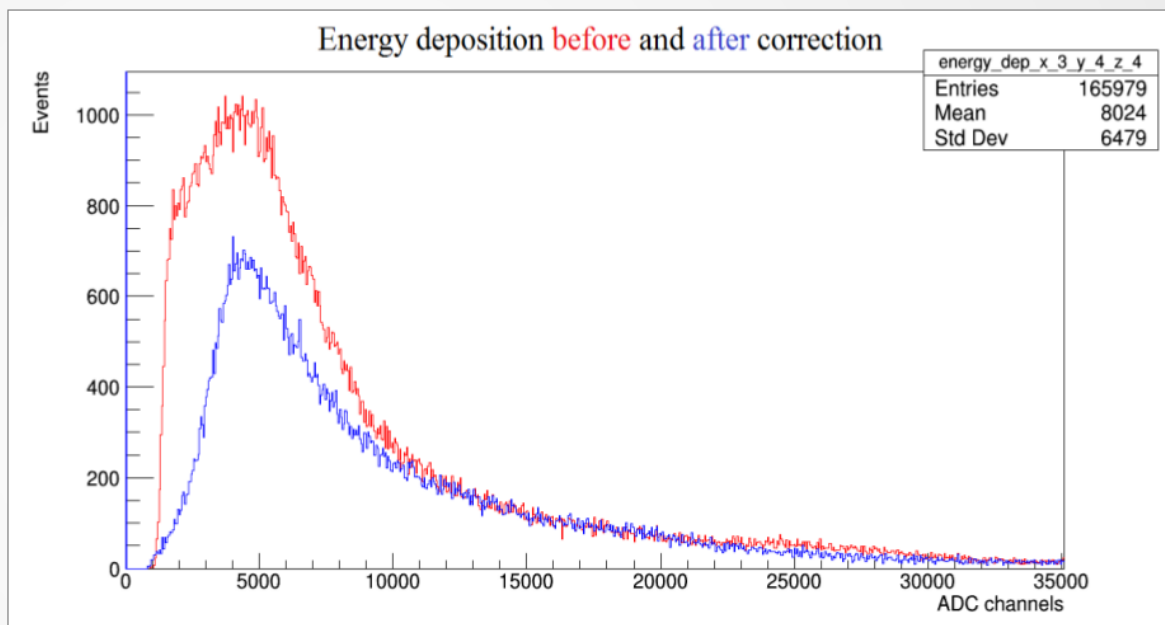
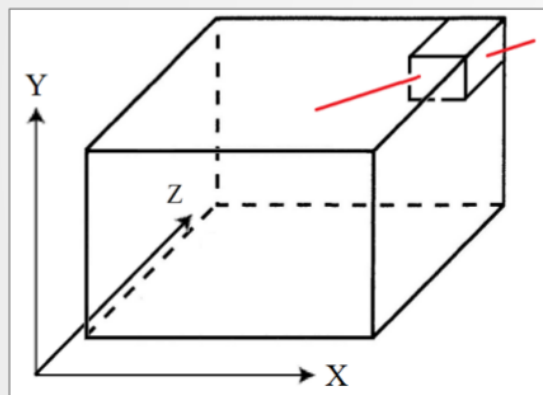

The adjusted charge is considered as if the particle has passed straight through the section, traversing 6×4 mm of the scintillator. In the case when the track did not pass through the section, it is impossible to correct the charge, the adjusted energy deposition is considered to be zero.

Summary:

- forward hadron calorimeters will be widely used in many ion-ion experiments
- muon calibration is important and need to be done in a best way (signal processing)
- transverse and longitudinal segmentation is a good feature to develop a smart 3D algorithms to select straight muon tracks

Outlook:

- further improvements for 3D muon track selection
- implement waveform signal processing to FPGA based solutions

Thank you for your attention!

ご清聴ありがとうございました。！

Backup slides

