

Lumi Software Update: Pixels

- Software Status
- New Design
- Software Update
- Differences to Strip-Sensor Design
- Outlook

Lumi Software before Pixels

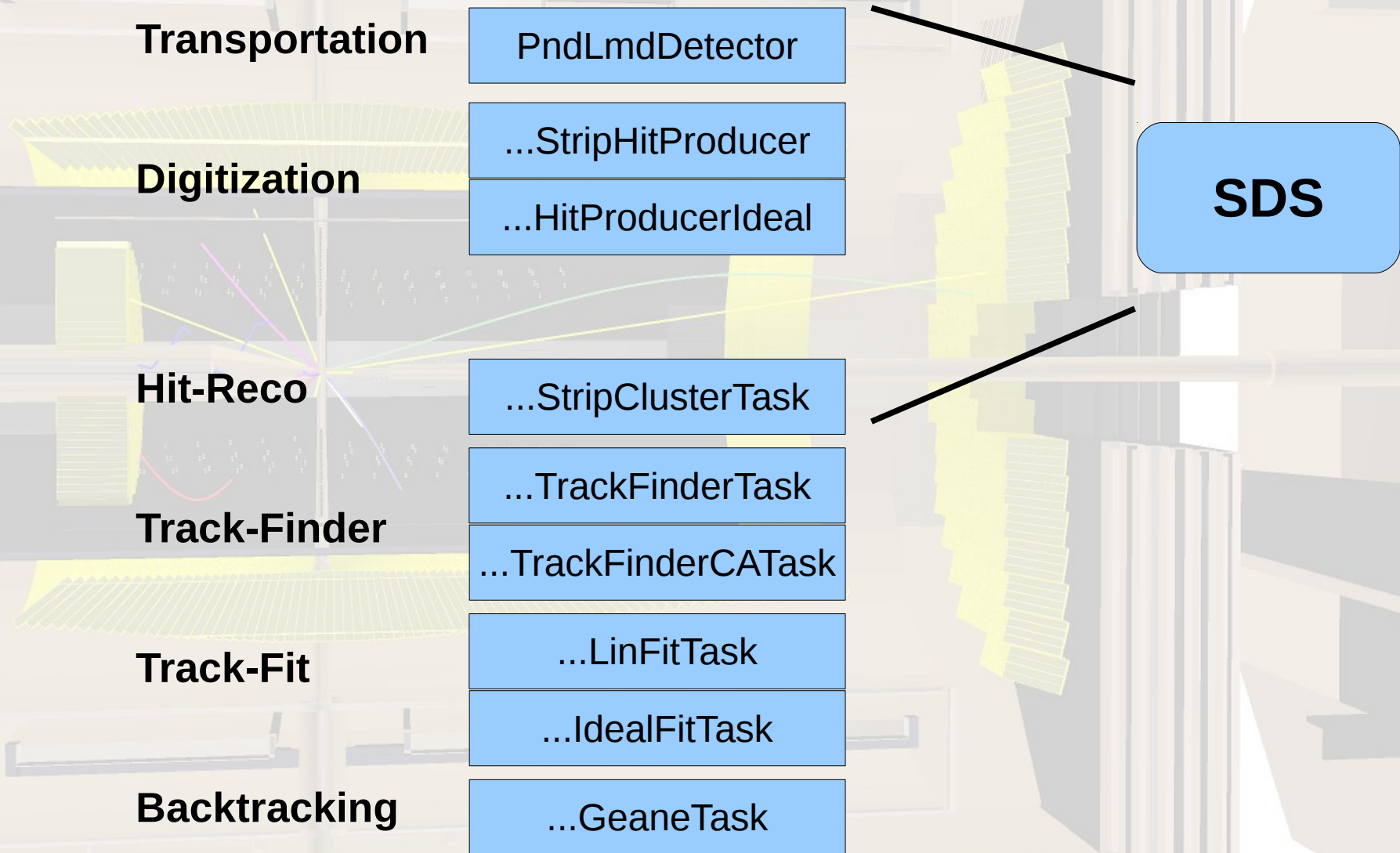

New Lumi Design with Pixels

HV-Maps:

- 2*2 cm modules
- 100*100 μm pixels

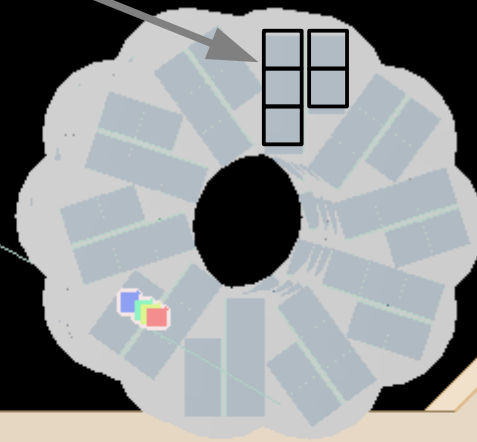

New Lumi Design with Pixels

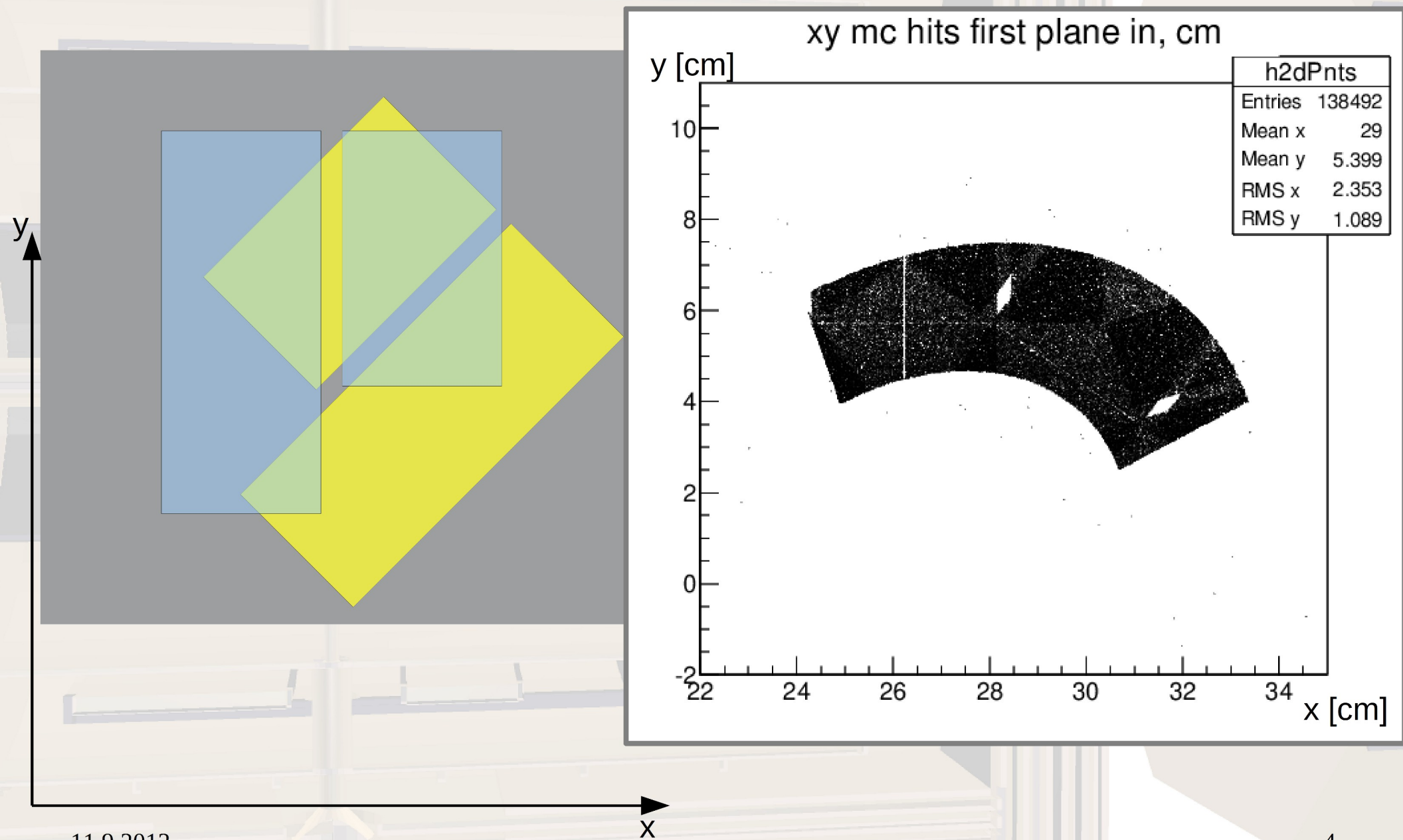

Lumi Software Update

Transportation

PndLmdDetector

Digitization

...StripHitProducer

...HybridHitProducer

...HitProducerIdeal

...PixelHitProducerFast

Hit-Reco

...StripClusterTask

...PixelClusterTask

Track-Finder

...TrackFinderTask

...HitMergeTask

...TrackFinderCATask

Track-Fit

...LinFitTask

...IdealFitTask

Backtracking

...GeaneTask

...QATask

SDS

New Macros:

```
runLumi1FastDigi  
runLumi1PixelDigi  
runLumi2PixelReco  
runLumi2bHitMerge
```

Pandaroot LmdPixel Update

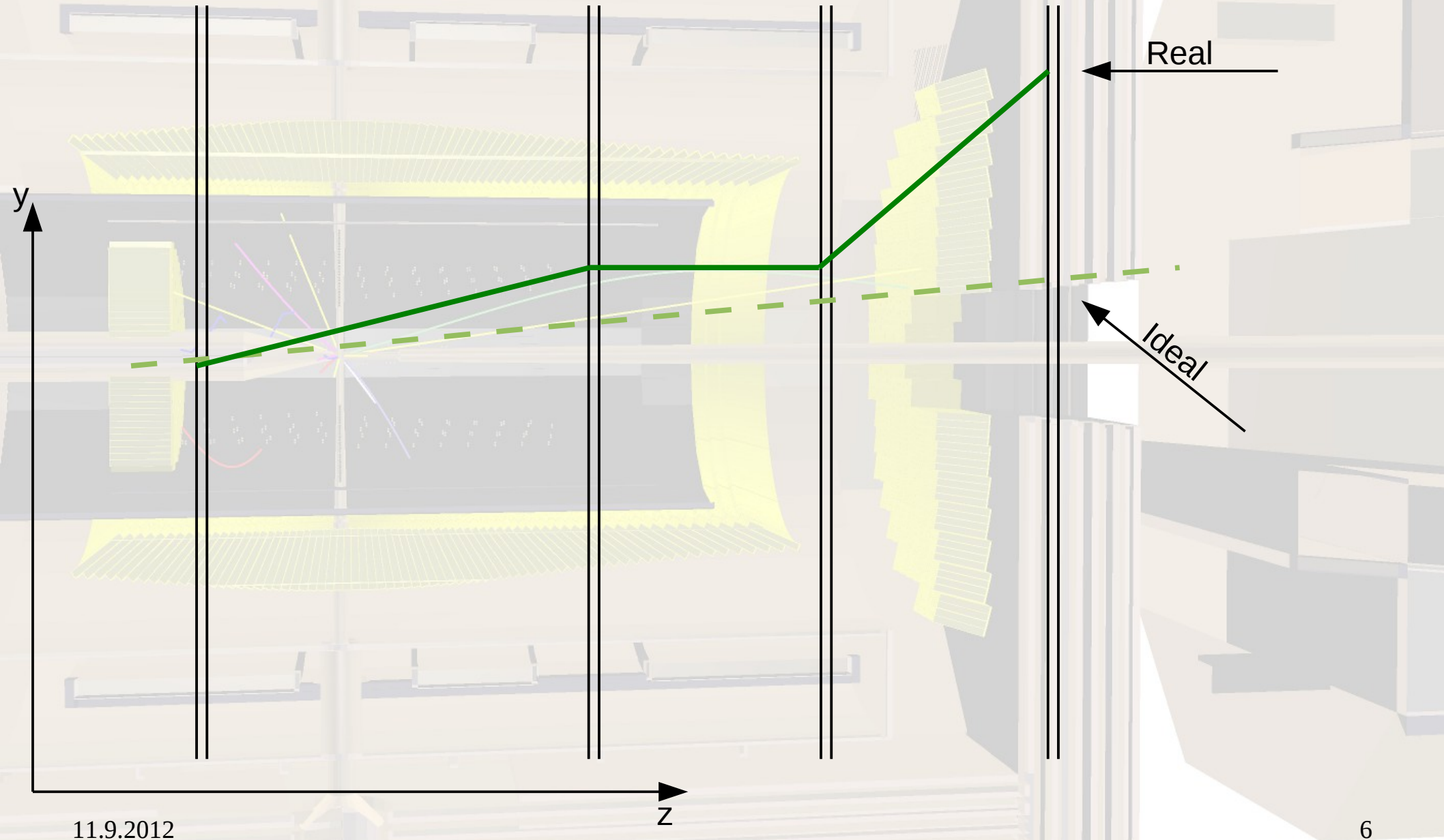

11.9.2012

Pandaroot LmdPixel Update

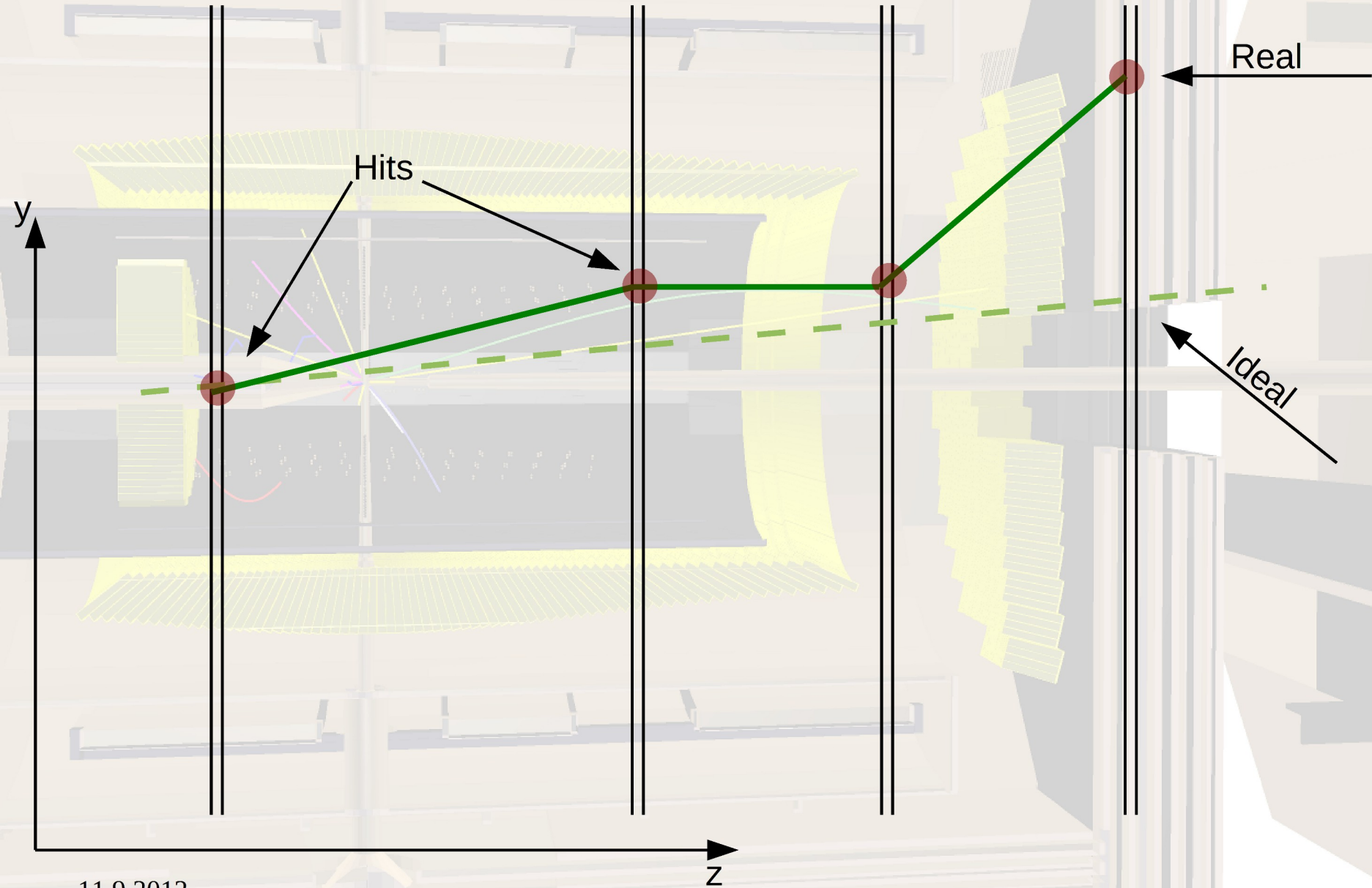

Pandaroot LmdPixel Update

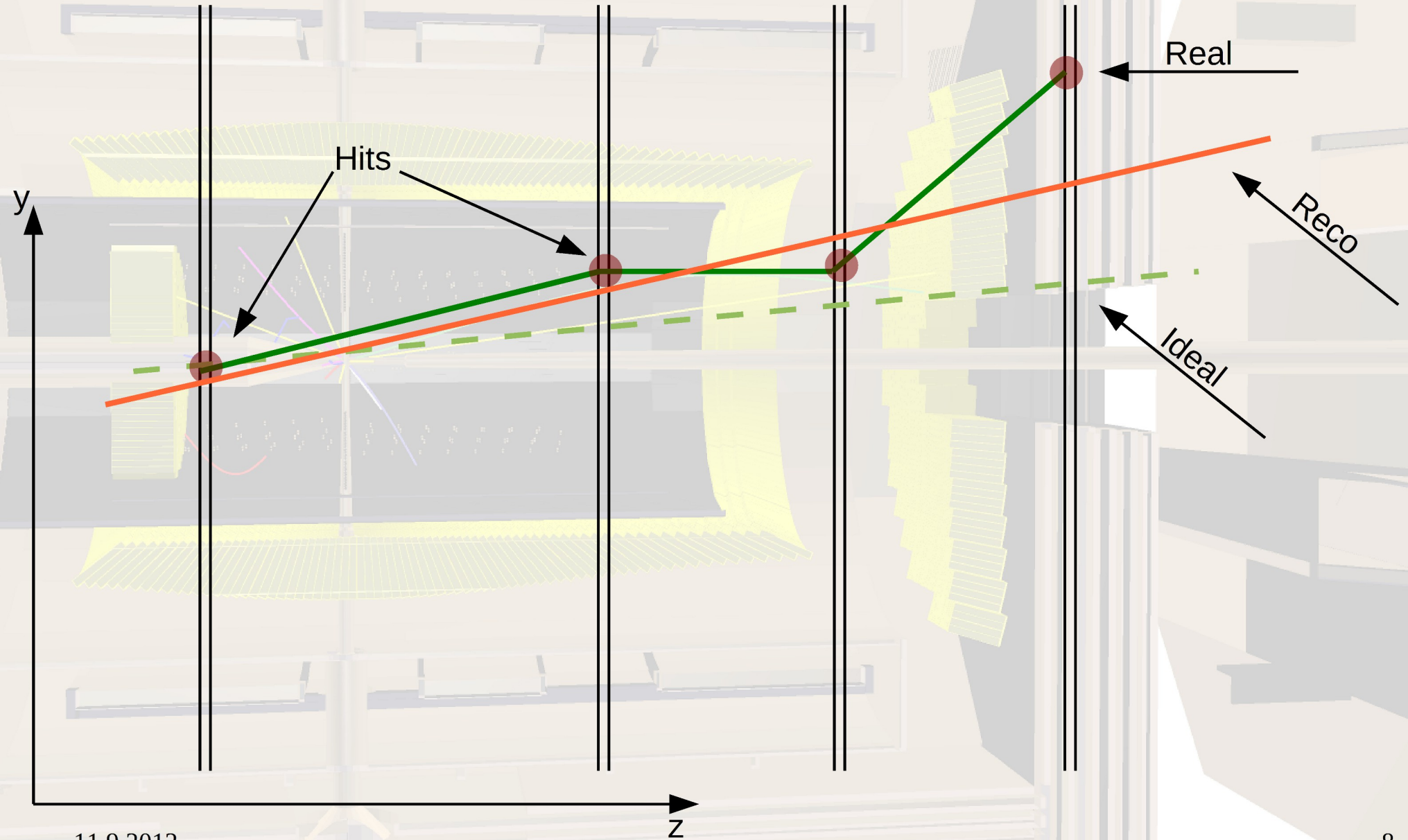

Pandaroot LmdPixel Update

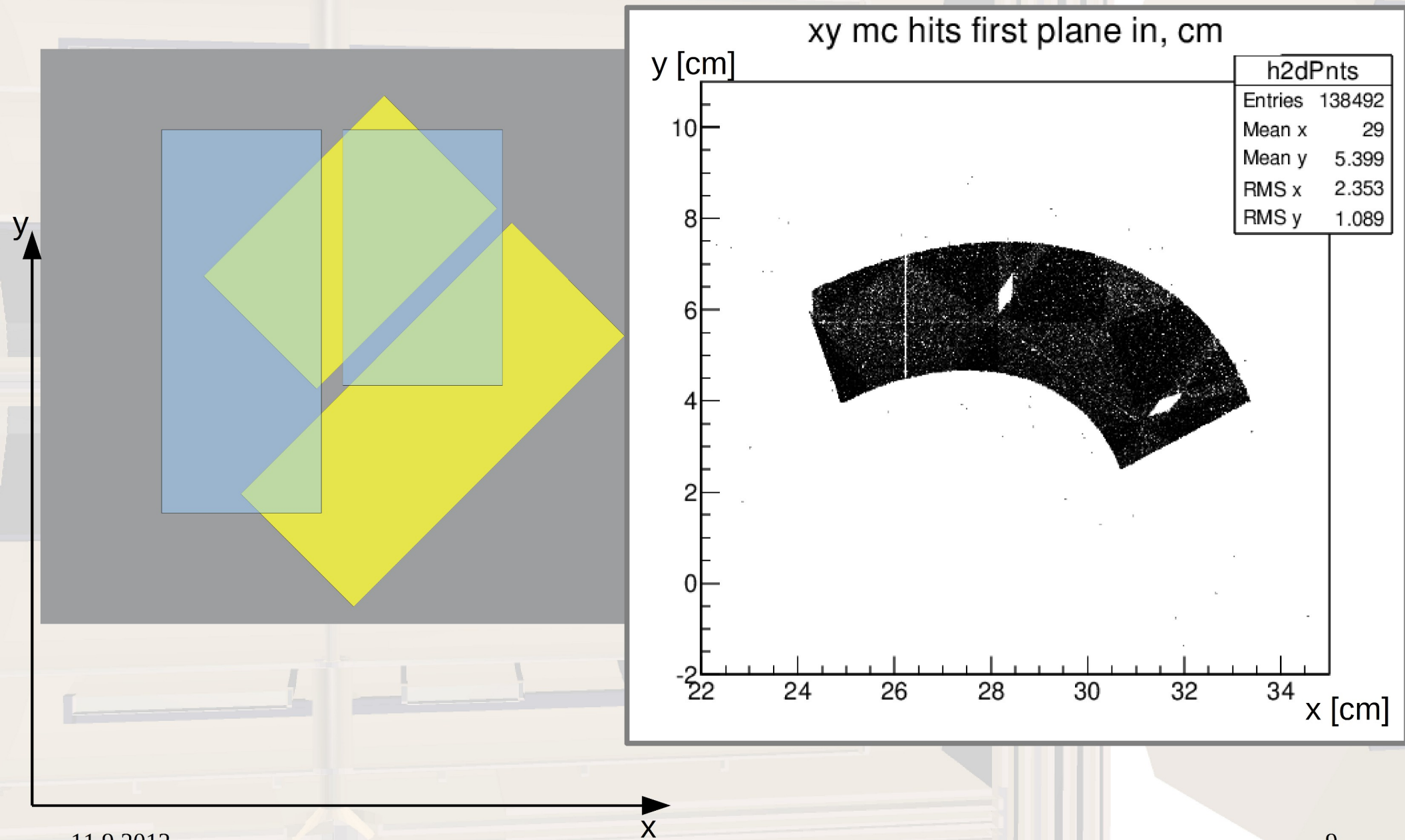

Pandaroot LmdPixel Update

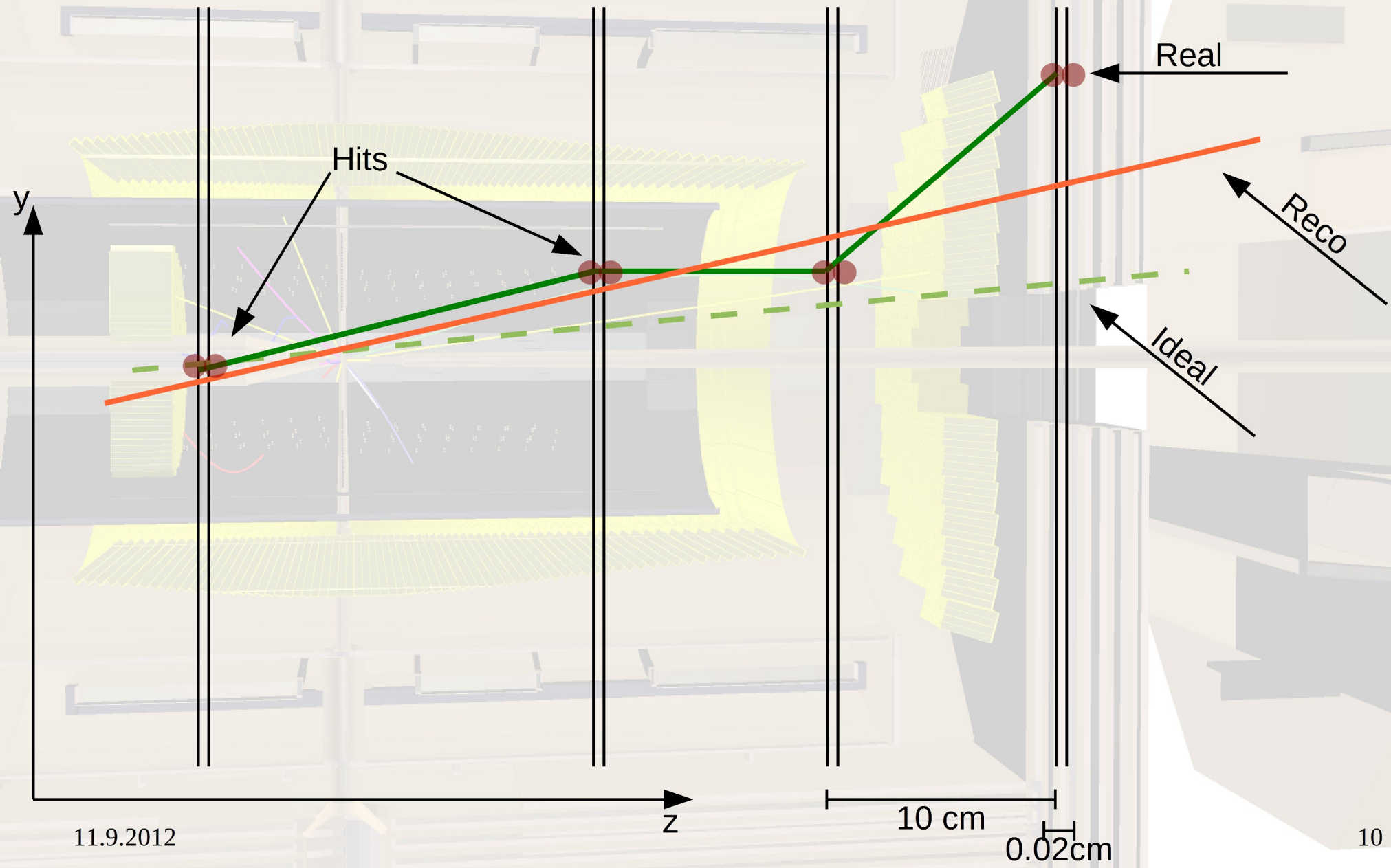

Pandaroot LmdPixel Update

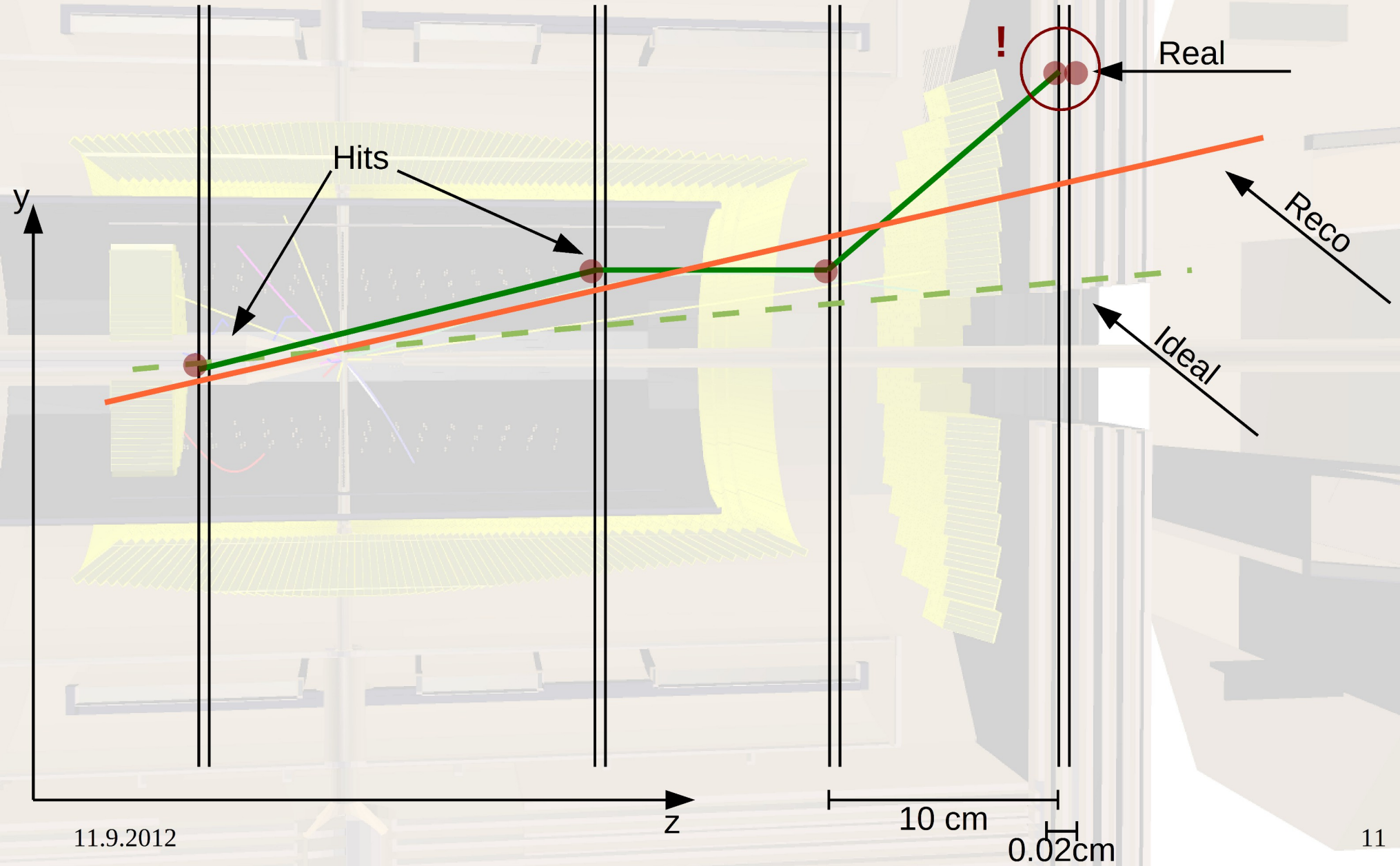

Effect on Track-Follower

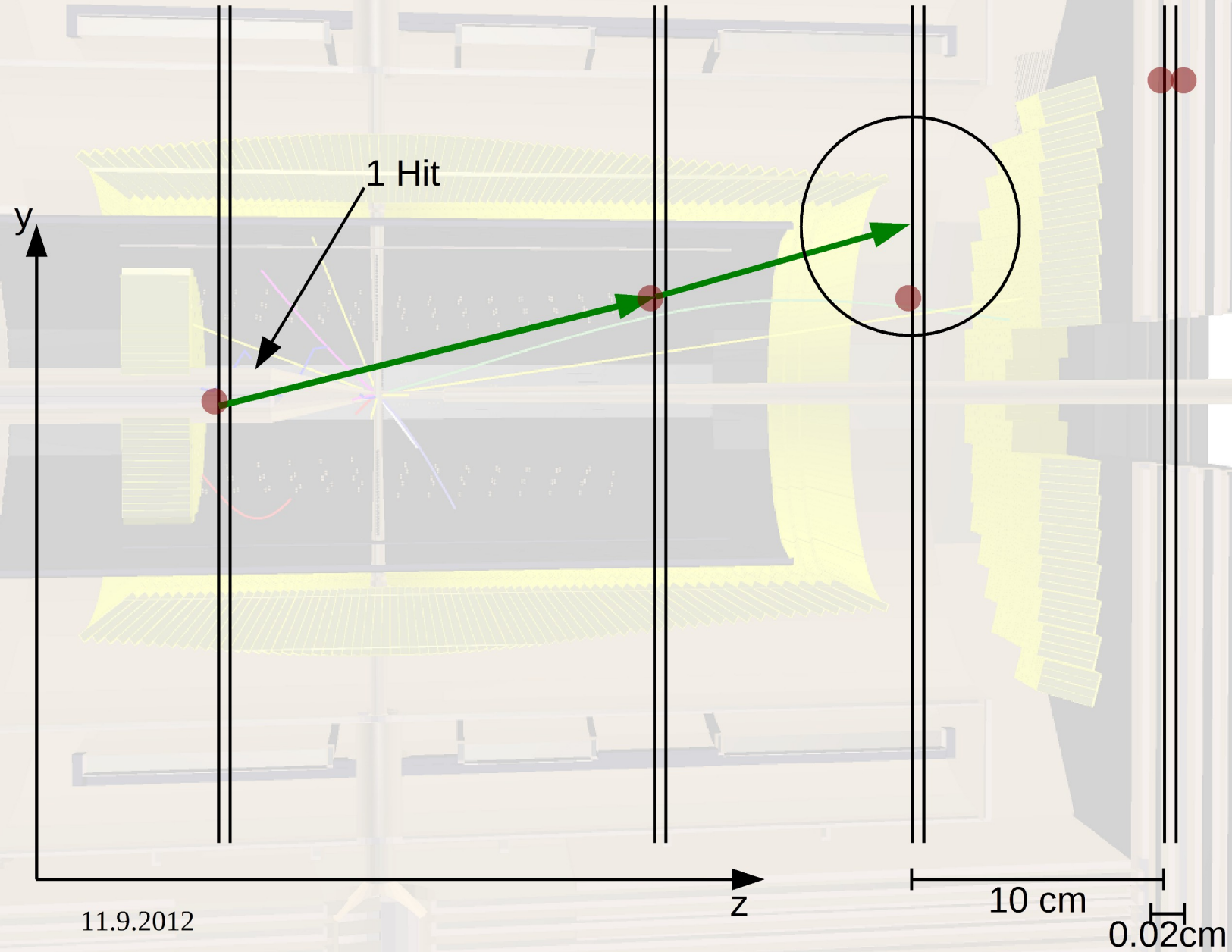

Effect on Track-Follower

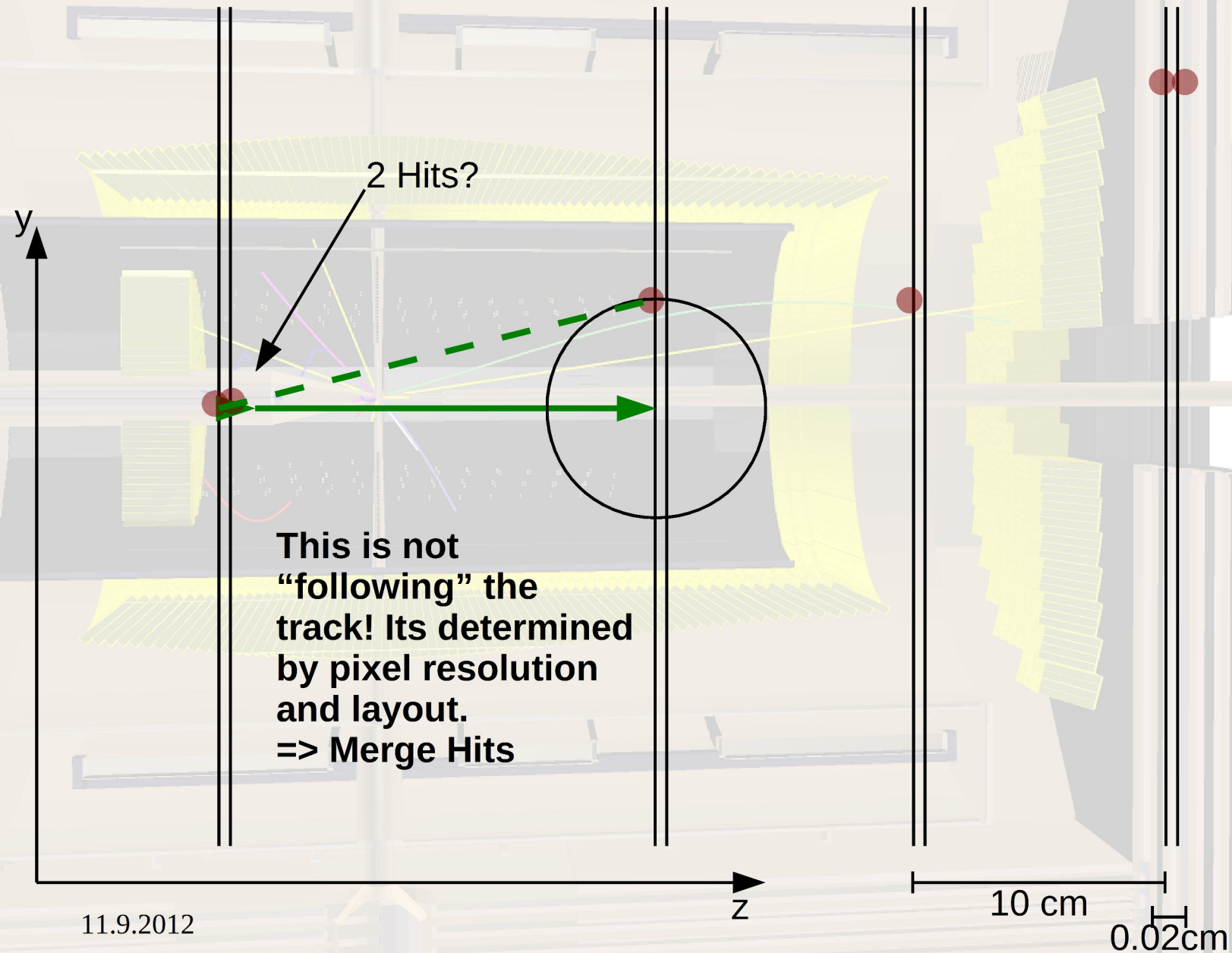

Effect on Cellular Automaton

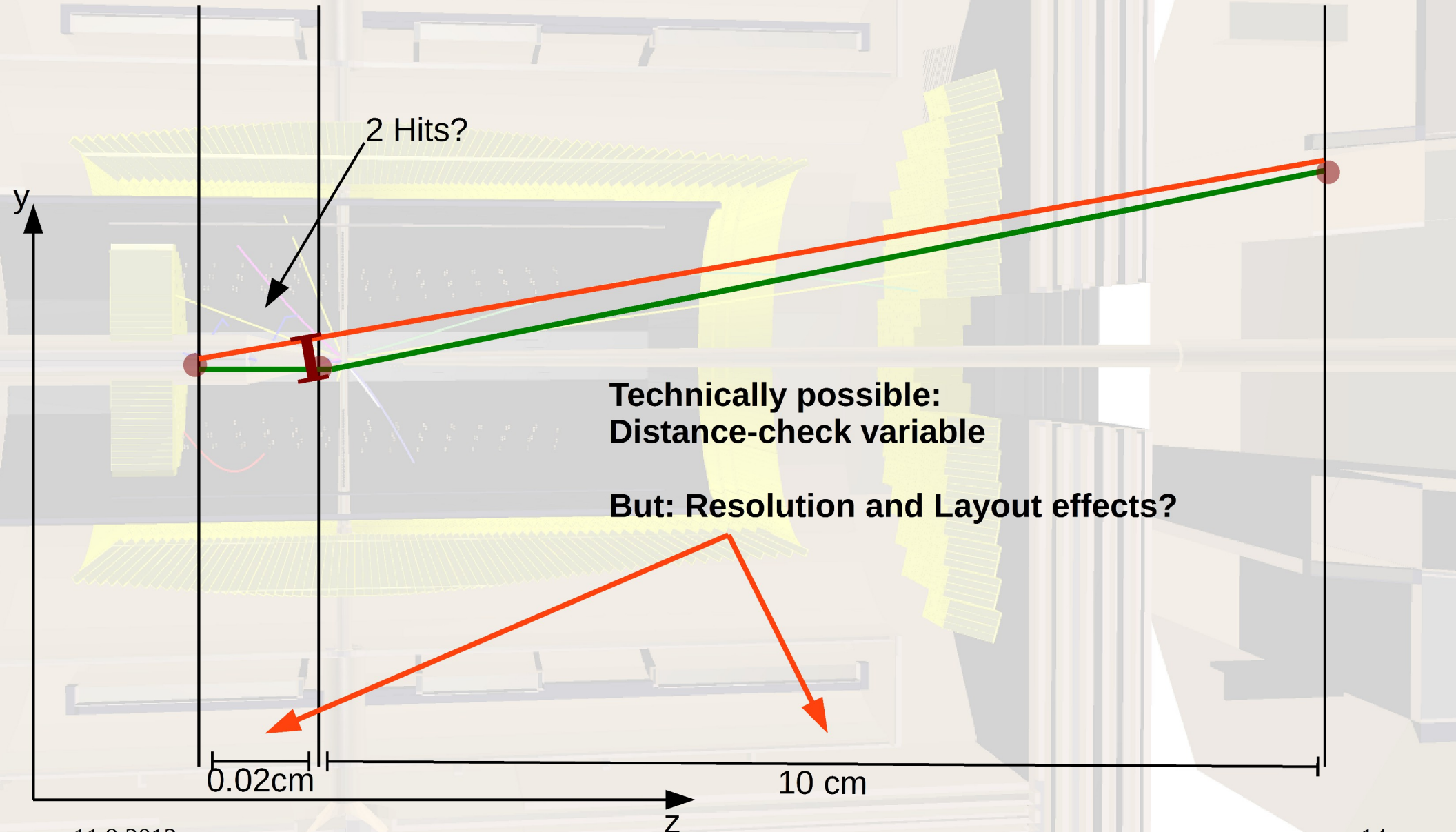

Effect on Trackfit

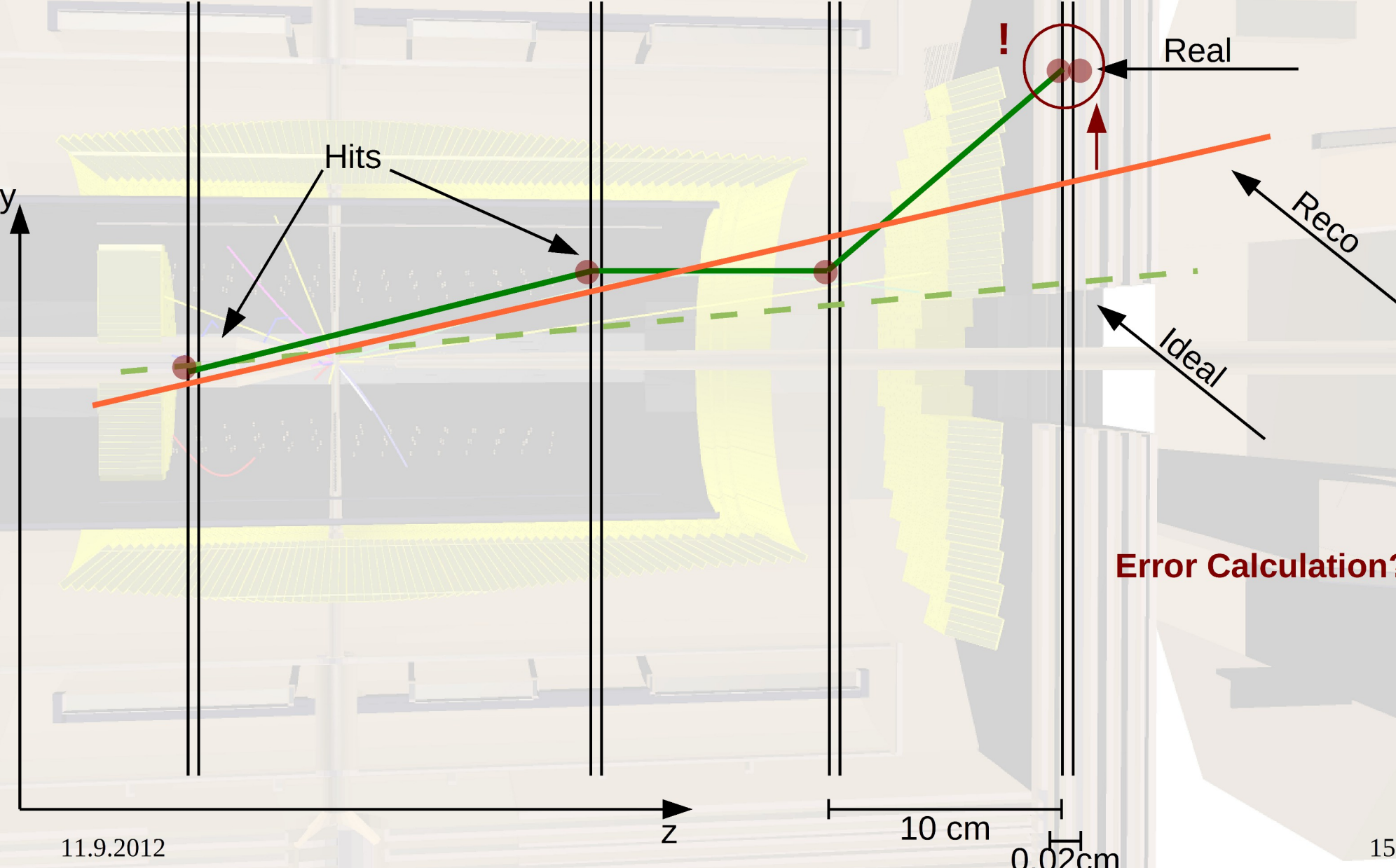

11.9.2012

Error Calculation?

Hit-Resolution

$X_{MC} - X_{rec}$

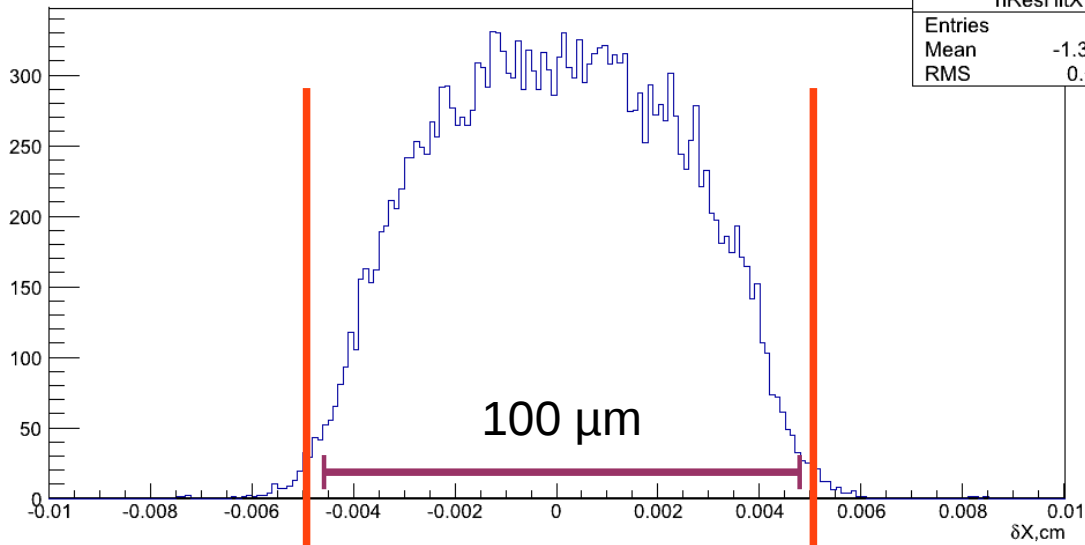

$Z_{MC} - Z_{rec}$

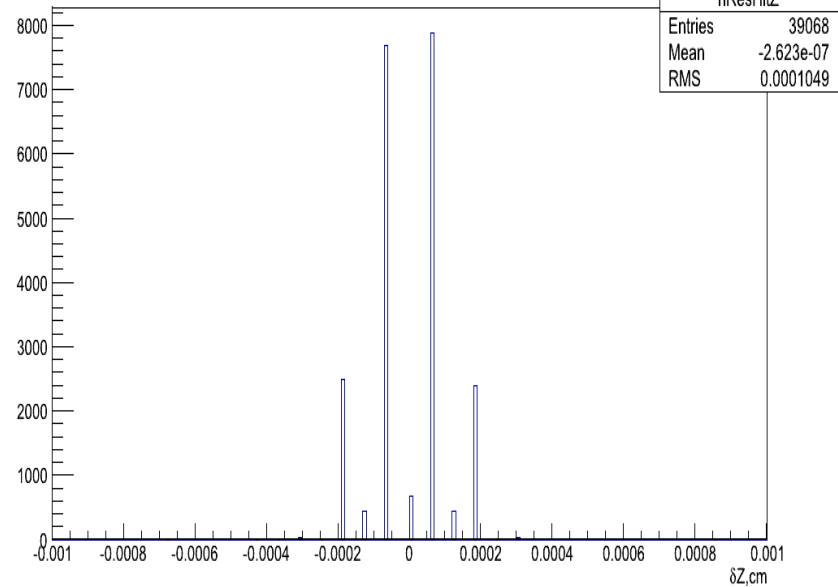

$Y_{MC} - Y_{rec}$

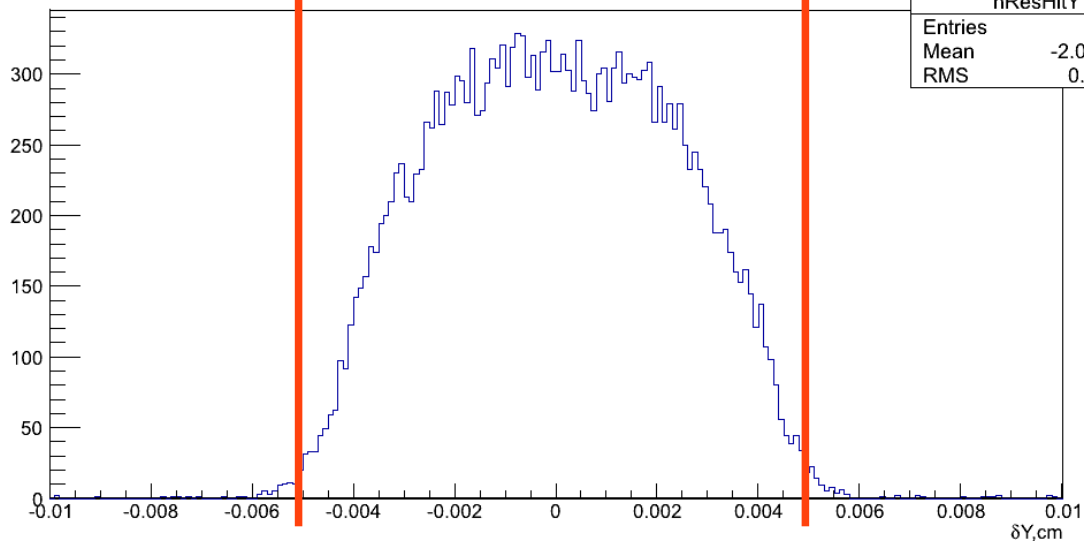

Dipole rotation
=> Backmapping to
local Lumi coordinates

Polarangle-Resolution

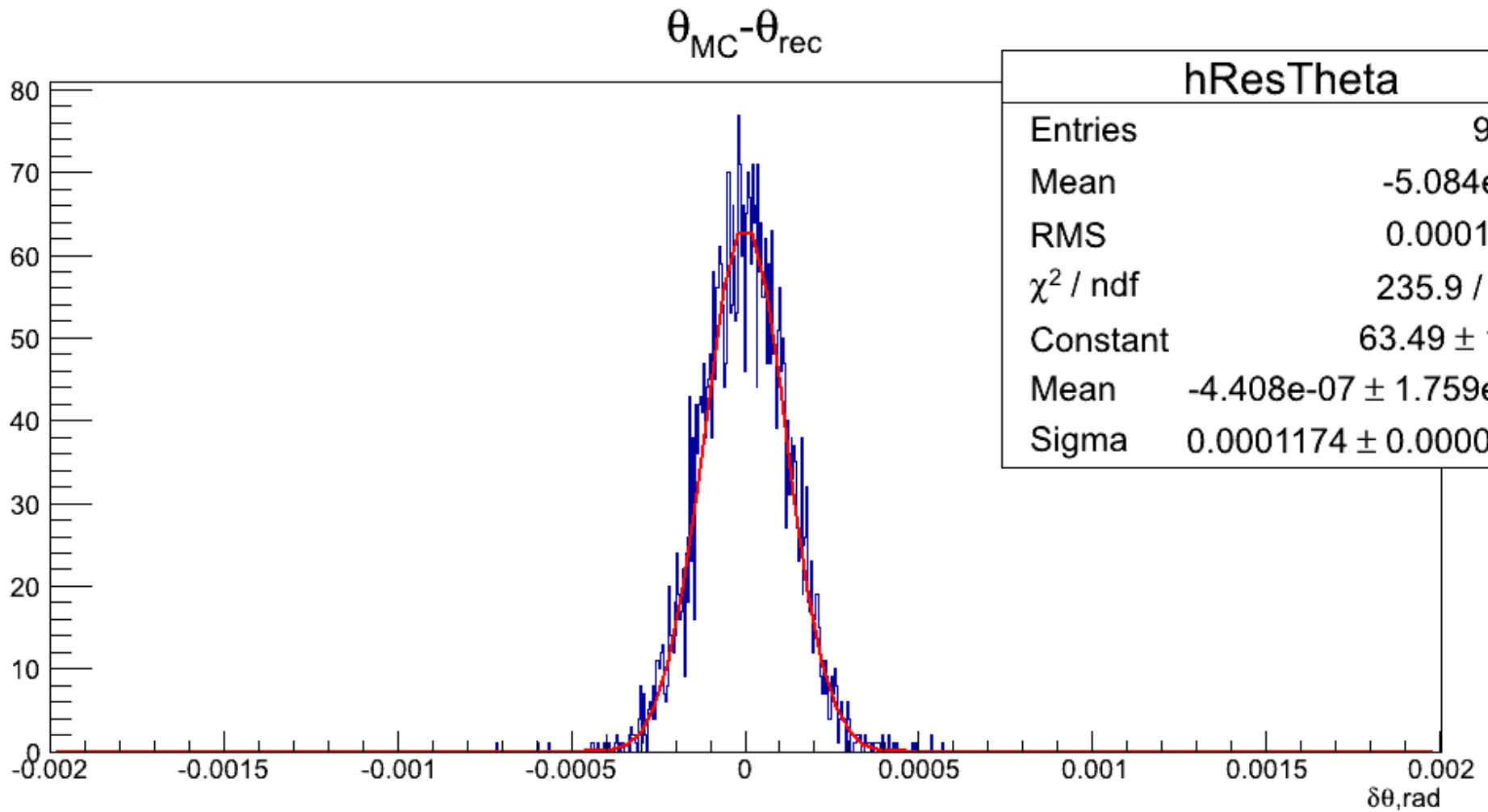

Outlook

Hit Reconstruction:

- Pixel Reco in local coordinates

Tracking:

- Update Cellular Automaton
- Test “multiple hit per plane” search
- Test “multiple hit per plane” fitting
- Check more sophisticated trackfit like Kalman

General:

- Optimize Pixel-Design
- Comparison with Strip-Design
- Check effects of hole in acceptance