

Design of the coil and SC cable for the CBM magnet

Alexey Bragin, Vassily Syrovatin

Budker Institute of Nuclear Physics, Novosibirsk, Russia

November, 2019

Main parameters of the coil

Coils parameters	Values now	Values, May 2018
Inner diameter of the winding, mm	1396	1390
Cross section sizes of the winding:		
height, mm	132	132
radial thickness, mm	157	160
Number of turns in one coil (33x52)	1716	1749
Number of layers in one coil	52	53
Interlayer insulation, mm	0.3	0.3
Operating current I_0 , A	666	686
Test current, $I_0 \cdot 1.05$, A	700	720
Magnetic field on the coil B_{max} , T	3.6	3.9
I_0/I_c ratio along the load line, %	~50 real cable	~57
I_0/I_c at fixed B, %	20	25
Helium temperature, K	4.5	4.5
Temperature of current sharing, K	6.8	6.8
Stored energy of the magnet, MJ	4.9	5.1
Cold mass of one coil, kg	~ 1800	~ 1800
Cold mass of one coil SC winding, kg	800	800
Inductance of the magnet at operating current, H	~21.2	~22.1
E/M ratio for two windings, kJ/kg	3.0	3.1
Mutual inductance between the coils, H	0.21	0.22
Vertical force on one coil toward the yoke, MN	3.0 (700 A)	3.2

Coil design, cross-section of the upper coil

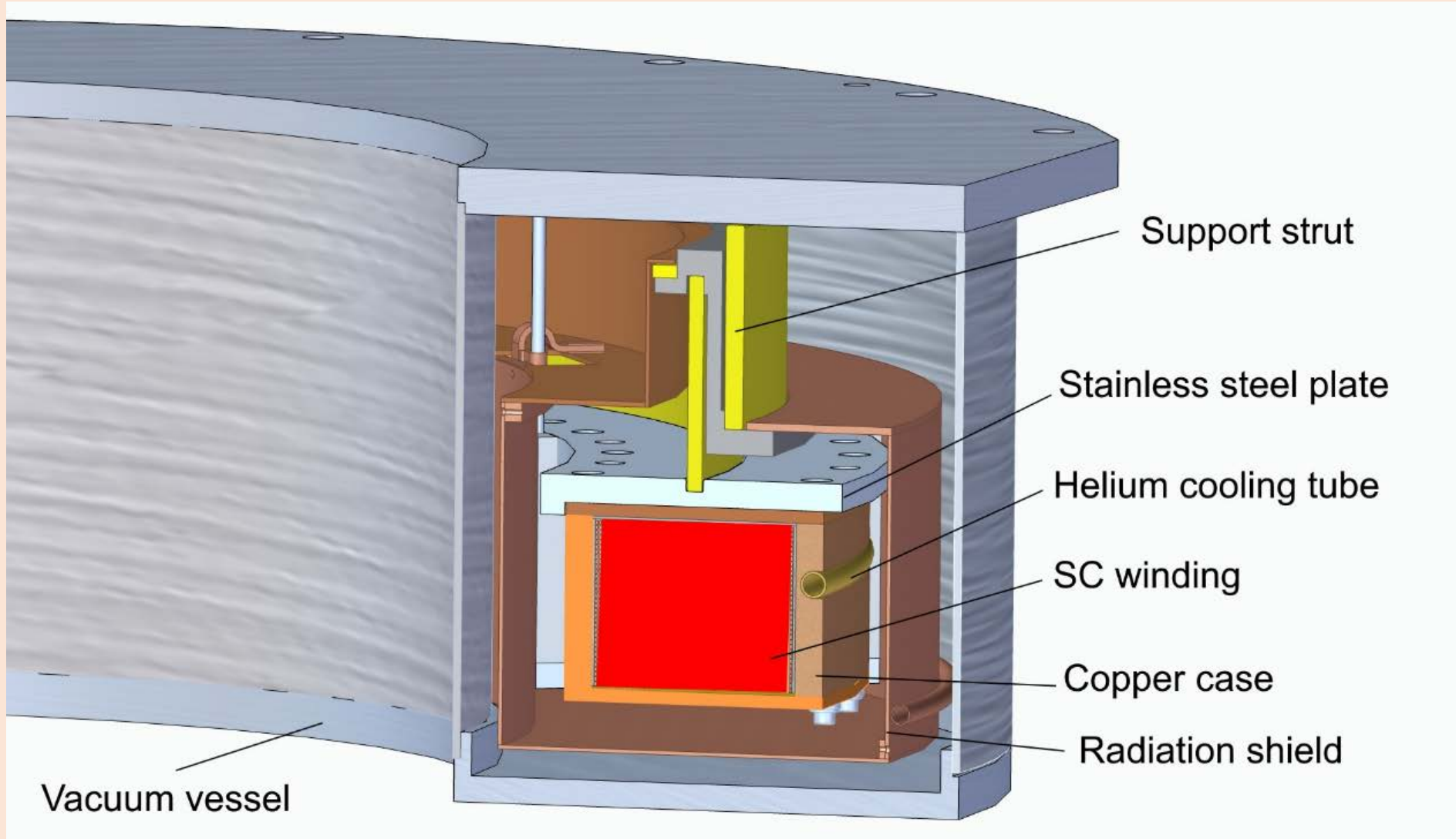

Assembling stage

Beginning of the winding procedure
first layer
Winding tool is not
shown.



The winding is finished

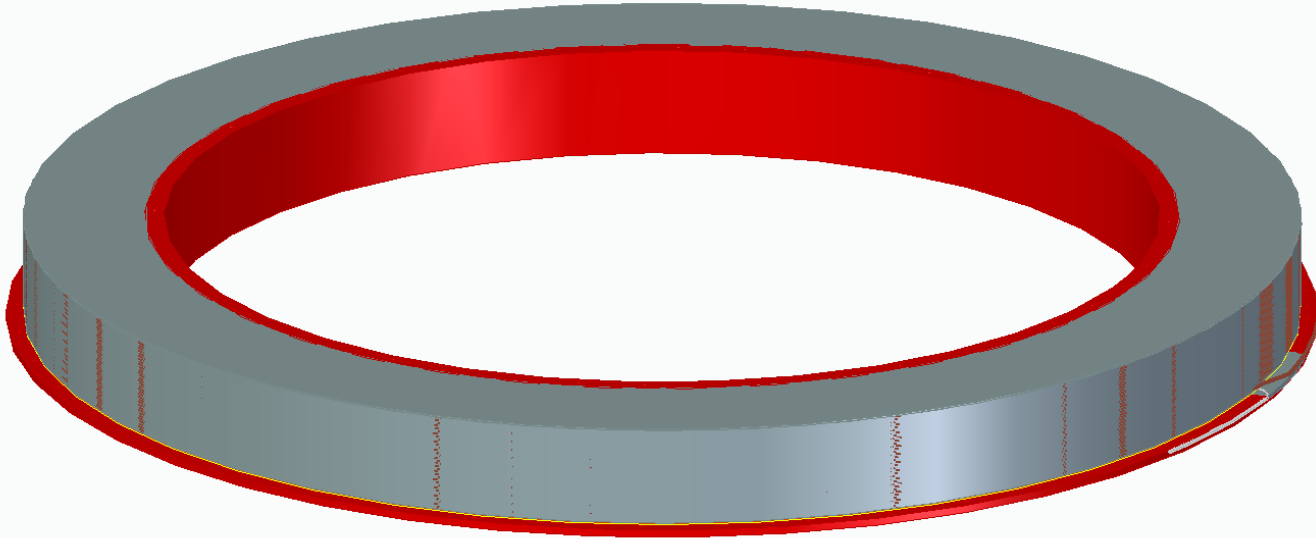

The winding will contain two pieces of SC cable. The length of one half is ~ 4.6 km.

Dry process of winding.

The splicing of the cable will be hidden in the groove of the wall of the copper case.

The thickness of the wall is 8 mm.

The length of the splicing will be ~ 1 m in the place opposite to the support struts position.

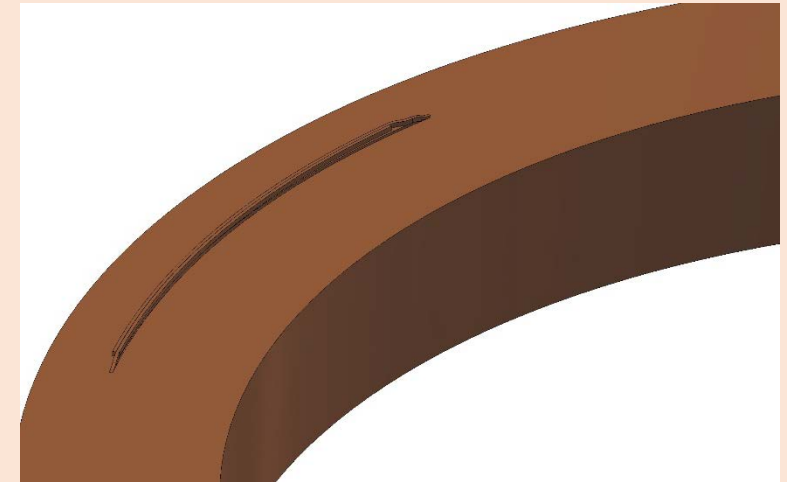

Assembling stage, continued

The copper case is assembled

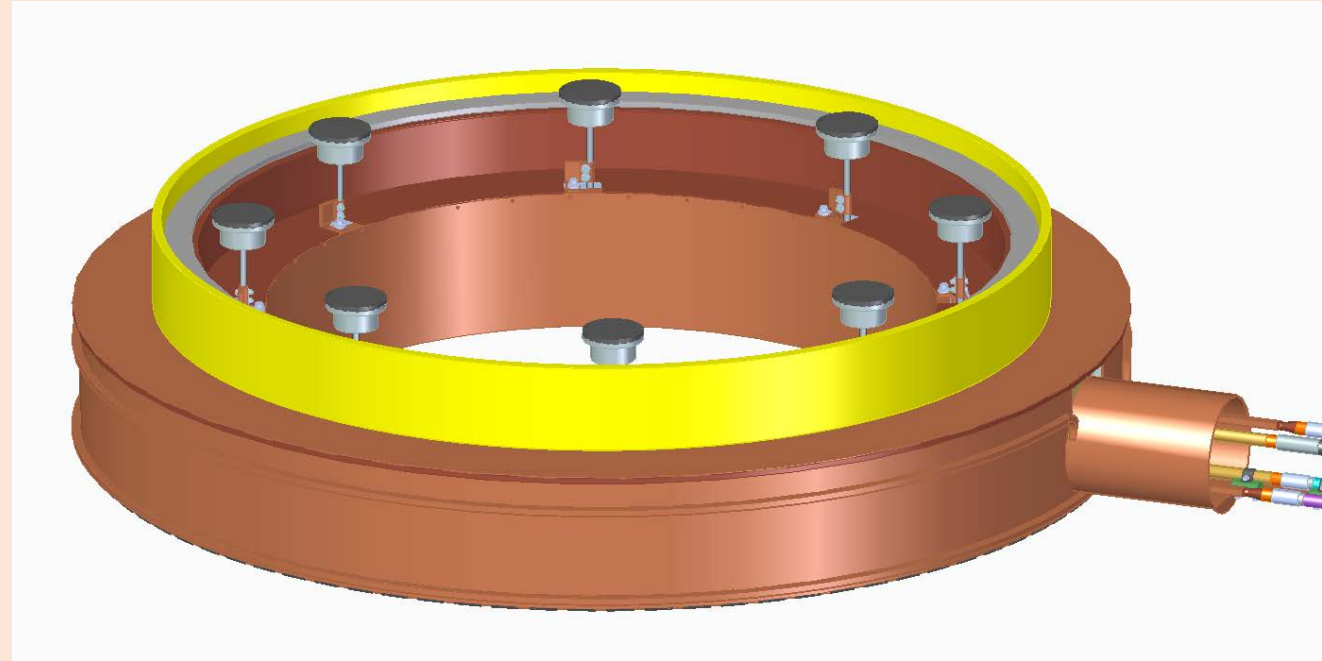
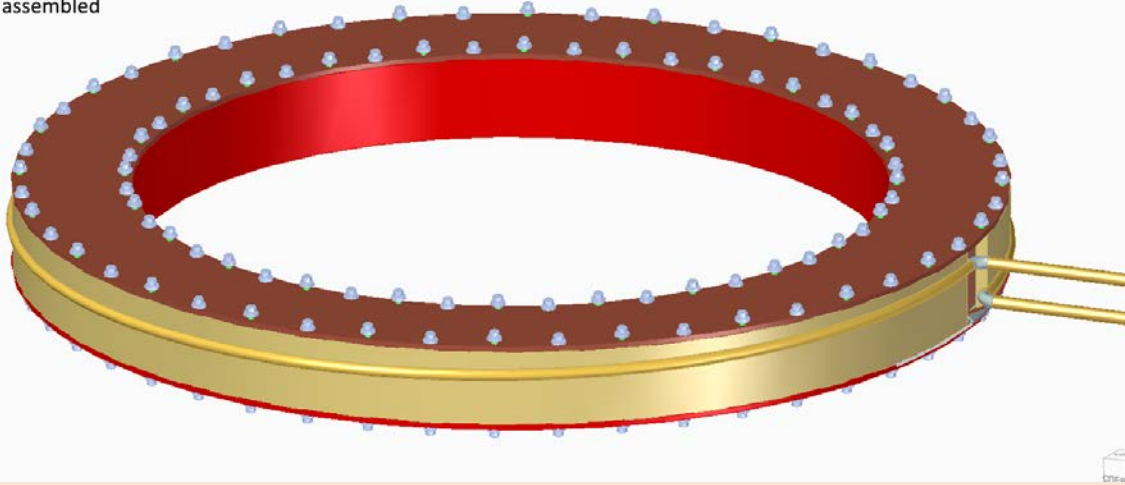

The assembled coil with radiation shield. The shield is cut to avoid the eddy current.

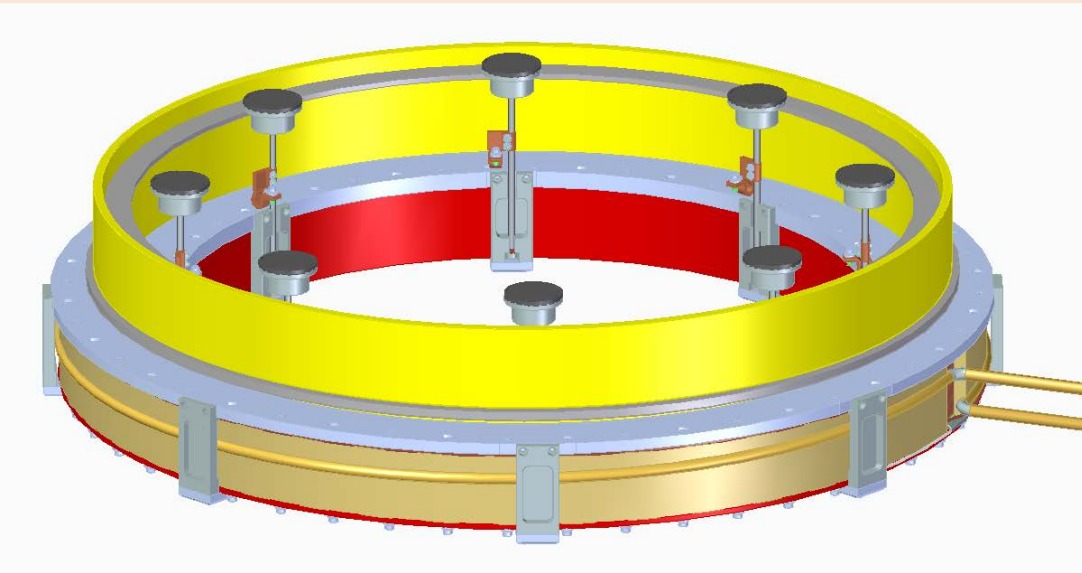

The assembled coil with stainless steel plate and the support system.

SC cable

The six pieces of SC cable was manufactured.

The insulation is 0.1 mm of Kapton and 0.2 mm of glass-fiber cloth. The glass fiber cloth will have silane grease having hydrophobic properties.

The insulation process had been started in November 2019.

Routing 1 kV quality testing

The breaking voltage test result is 13 kV.

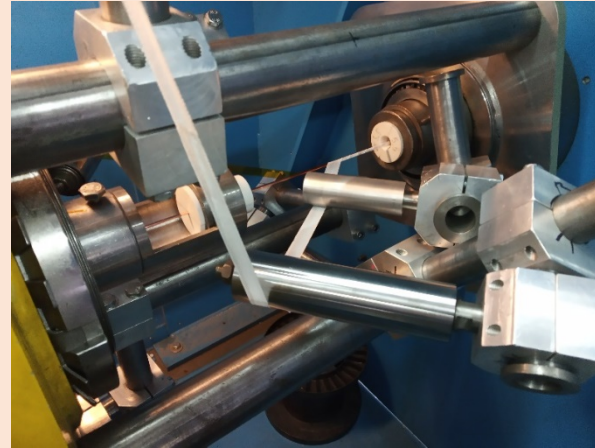

SC cable parameters (monolith technology)	
Rectangular bare sizes: h × w, mm	2.02×3.25
Insulated sizes: h × w, mm	2.62×3.85
Cu/NbTi ratio	7/1
Critical current 8T@ 4.2K, A	>780
RRR measured on bare wire	>200
Number of filaments	713
Diameter of the filament, um	38
Twist pitch, mm	39
Length of one piece, km	5.2

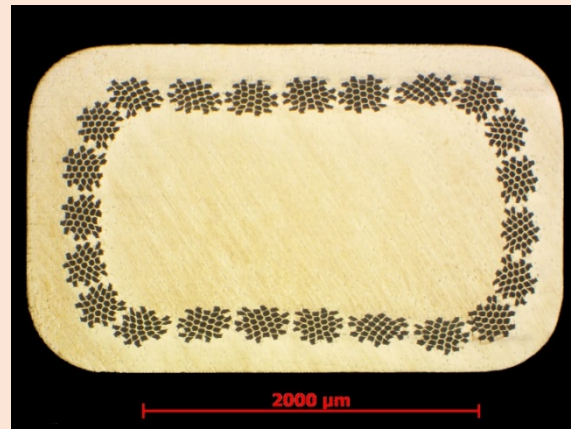
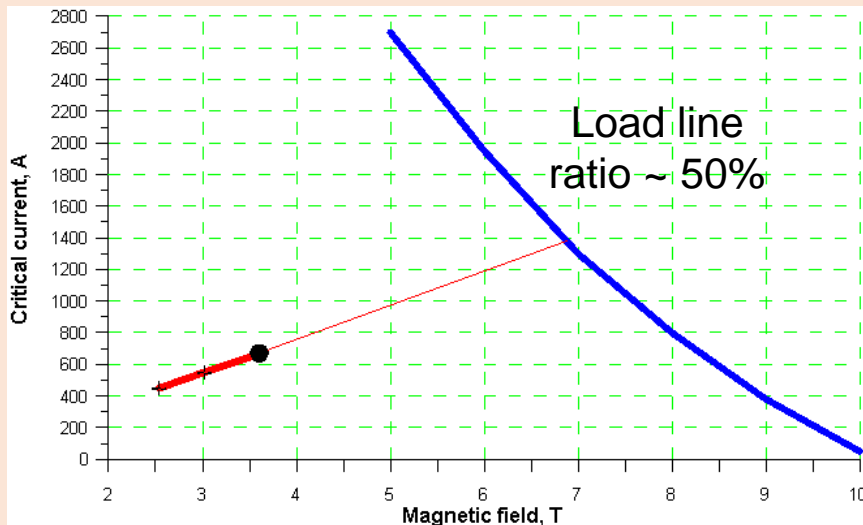

Cross-section photo of the wire



Six pieces of the wire were manufactured in December 2018 by Bochvar Institute, Moscow.

Impregnation tests of the mock-up coil – previous experience with Al_2O_3 compounds

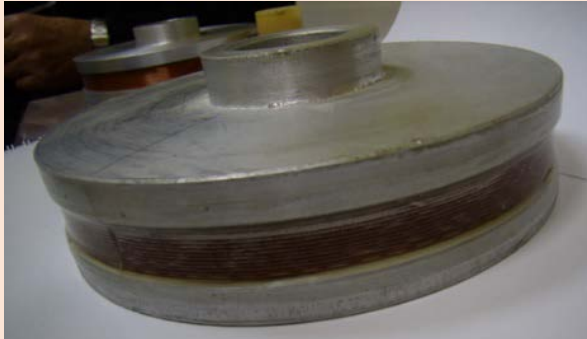

The coil sample for impregnation tests. The wire diameter is ~ 0.9 mm.

Epoxy resin with Al_2O_3 fine powder (3-5 μm) was used.

The cross-section shows that the powder does not go inside the winding.

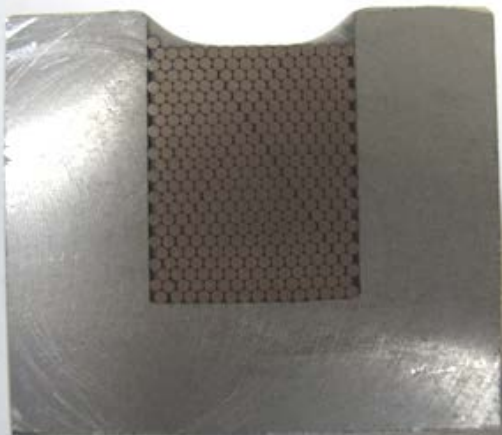

The 6 T solenoid was tested in 2018-2019. Only one training quench was at 5.8 T in 4.2 K bath cryostat. The maximal field was 7.5 T at ~ 4 K temperature.

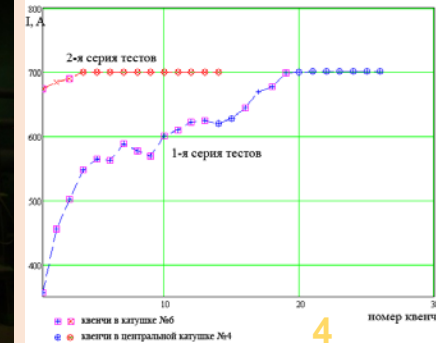
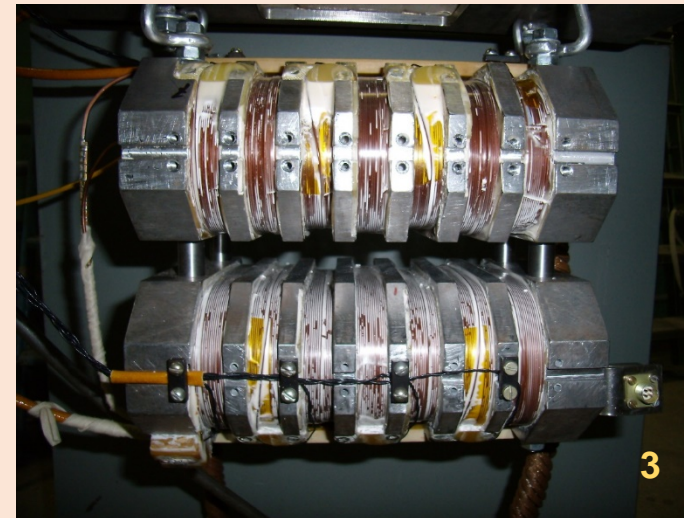

The short wiggler prototype tests:

1. One half before the impregnation.
2. After impregnation in a rubber bag.
3. The wiggler is assembled for testing.
4. The training behavior – critical current was reached. The training quenches were in one coil (defect) mostly.

Copper bobbin

i.d. is 102 mm

$L = 0.5$ m

20 + 2 layers

$I = 230$ A at 6.3 T

$I_0/I_c > 80\%$



Impregnation tests of the mock-up coil

The mock –up coil is 1 m length straight part of the CBM coil.
(The round coil with iron cylinder has disassembling problem.)

The epoxy compound is with Boron Nitride Powder 0.5-2 um
(Chengdu nuclear materials, China).

This epoxy compound (BINP specification is «ЭПК-5» SLAC) was
several times used in the superconducting magnets manufacturing.

Main purposes of the tests are:

1. To see the behavior of the epoxy compound with too fine boron nitride powder.
2. The filling ability of such compound to penetrate the CBM coil structure. What is the channel width?

Poiseuille equation for volumetric flow in the channel:

$$Q = \frac{\pi \cdot d^4 \cdot (P_1 - P_2)}{128 \cdot \mu \cdot l},$$

m^3/s – the width of the channel is the most important parameter.

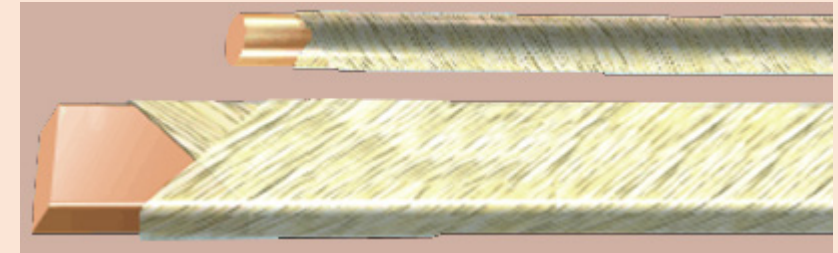

Copper wire, wrapped with fiber glass cloth
Impregnated with gluceryl-phthalate varnish.
Bare sizes are 2 mm x 4 mm.

	У.З	комн.		Температура, °С		Время, час	
				90	120		
ЭПК-5 (SLAC)	1. Эпоксидная смола ЭД-22	100	70-90	1. Перелить в бачок смолы, перемешать. Ввести частями наполнитель. Тщательно перемешать.* Измерить температуру. Температура должна быть 70±5°С. 2. Ввести отвердитель - ИМТГФА. Тщательно перемешать.* 3. Ввести продукт АГМ-9, перемешать. Тщательно перемешать.* 4. Ввести ускоритель-УП-606/2. Тщательно перемешать.*			
	2. Эпоксидная смола ДЭГ-1	30	70-90				12
	3. ИМТГФА	100	70-90				2
	4. Продукт АГМ-9	1.35	комн.				6
	5. Ускоритель-УП-606/2	0.375	комн.	2	4	10	
	6. Наполнитель - электрокорунд белый (окись алюминия Al ₂ O ₃)	до 200	комн.	160	4	10	
				Примечание: Форму поворачивать на 180° через каждые 30 минут в течение первых 3-х часов.			

The epoxy compound has 5 components + filler. Temperature of the impregnation is 90 C. Intermediate temperatures are 120 and 160 C.

Total time is 46 hours.

Impregnation tests of mock-up coil - results

1. The pieces of the wire were placed as shown here.

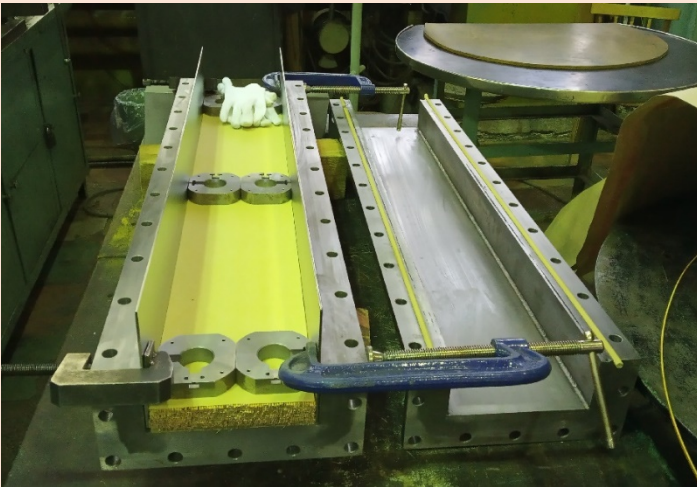

2. The layers of the wire were pressed in vertical direction. However, the gap was left on the top.

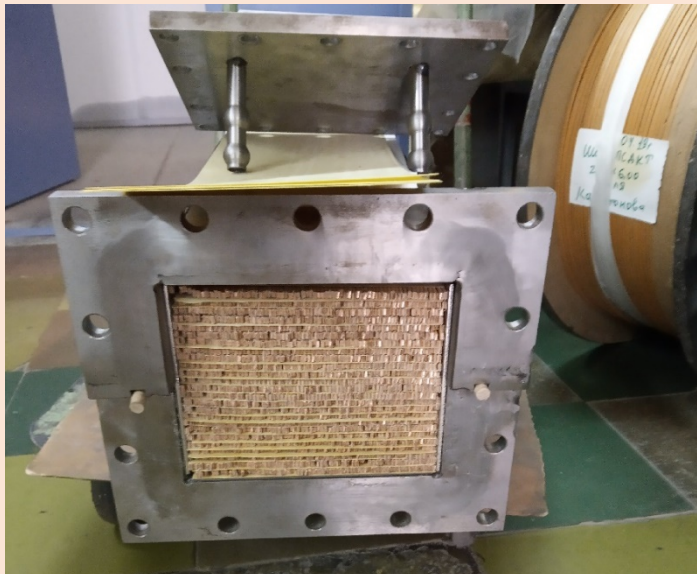

3. The view after assembling. The compound was penetrating from one side. About 2-3 bars of external pressure was applied during impregnation.



4. The view of the cut from 2 cm of the far end with respect to the filling side.

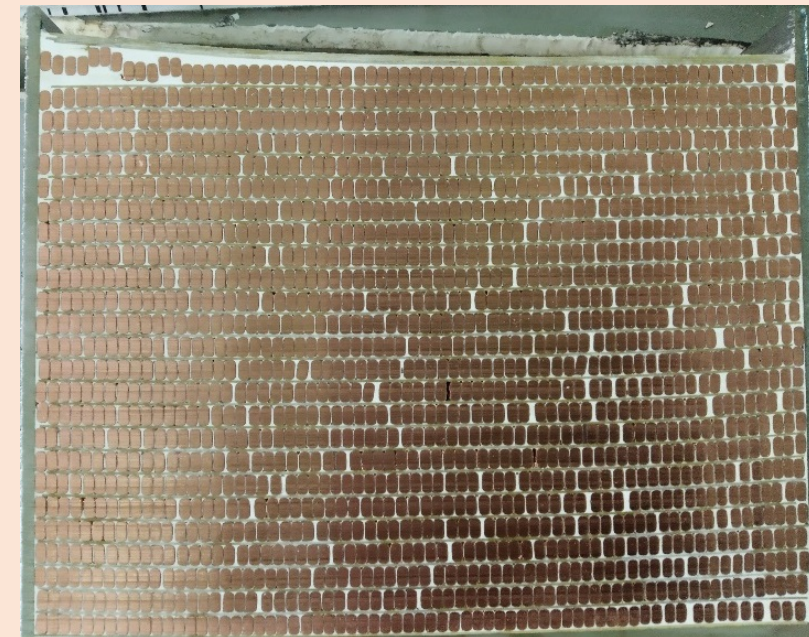

Impregnation tests of mock-up coil - conclusions

The previous experience shows that even the powder is not filling all space between the wires the training behavior is good. That is due to decreasing of contraction coefficient of the epoxy compound.

The BN compound first sample results.

Positive items

1. The boron nitride powder can be used as filler for already tested type of epoxy (SLAC).
2. The cured compound had homogeneous structure.

Negative item

The mock up coil was not completely impregnated. The channels are necessary.

The next mock up coil will be tested soon.

Results

The design of the CBM magnet coils is presented.

The design of the coils, winding and epoxy impregnation technology was discussed in BINP workshop. No principal problems was revealed.

The support struts should be manufactured and tested as soon as possible.

The superconducting cable is manufactured. The insulation process is going on, to be finished not later than March 2020.