

eTOF project overview and status

Ingo Deppner

Physikalisches Institut
der Uni. Heidelberg

Outline

- Introduction
- eTOF acceptance
- eTOF hardware and status
- Preparation for Run18
- Project milestones
- Summary



Event display of a Au + Au
reaction at 25 AGeV

CBM-STAR joint Workshop

- eTOF project is a joint project between CBM and STAR
- eTOF project is part of the BESII detector upgrade at STAR
- It comprises the installation, commissioning and operation of CBM TOF modules positioned at the east pole tip of the STAR apparatus during the BESII campaign
- It is part of the FAIR phase 0 program

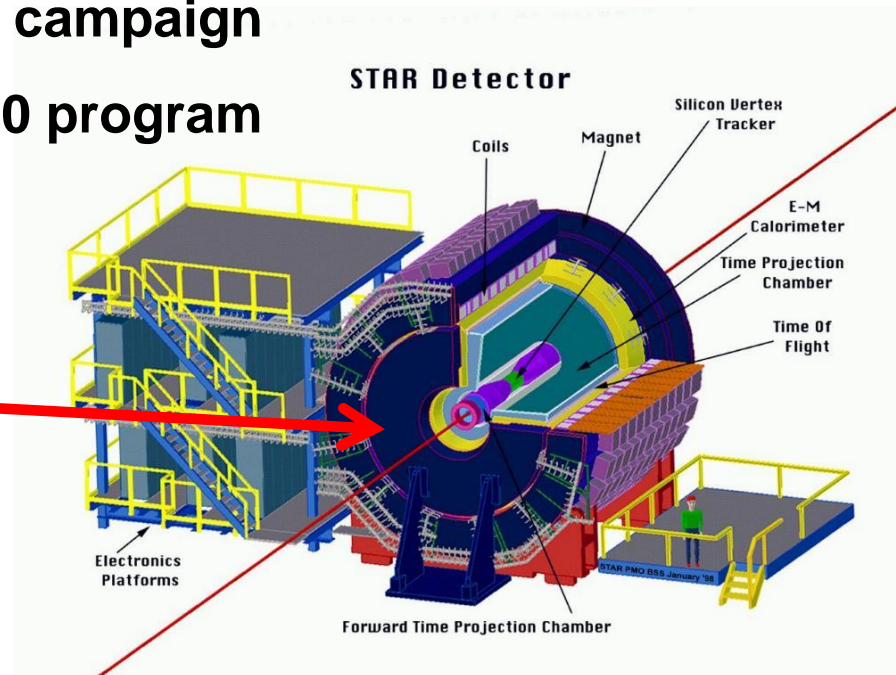
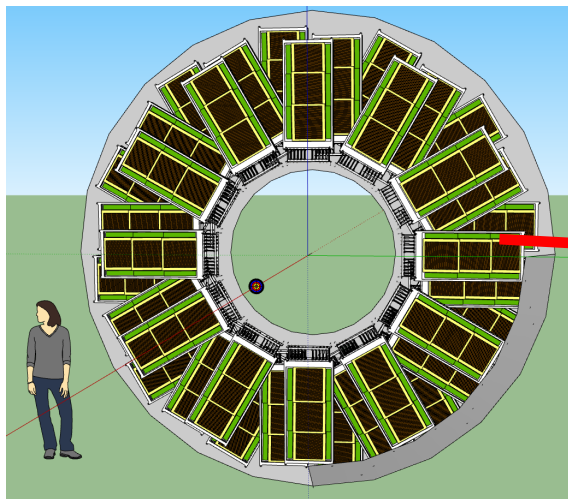

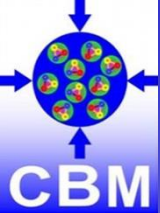

Benefits



Benefit for STAR:

- providing critical TOF coverage for BES II
 - PID extension to $y = 1.2$ in collider mode
 - access to energies from 4.5 to 7.7 GeV in the fixed target program

Benefit for CBM:

- providing a large-scale integration test of the CBM TOF system, including PID and calibration of the detectors (hardware and software)
- preparation for day one experiment at SIS 100

Benefit for CBM-TOF group members:

- participation in the analysis of the physics data provided by the CBM TOF detectors, including authorship of any publications from this data.





Physics Goals



The BES phase II program is designed to study the phase diagram of QCD matter (see Fig. 1). The program has several goals:

The general physics goals are common for STAR and CBM

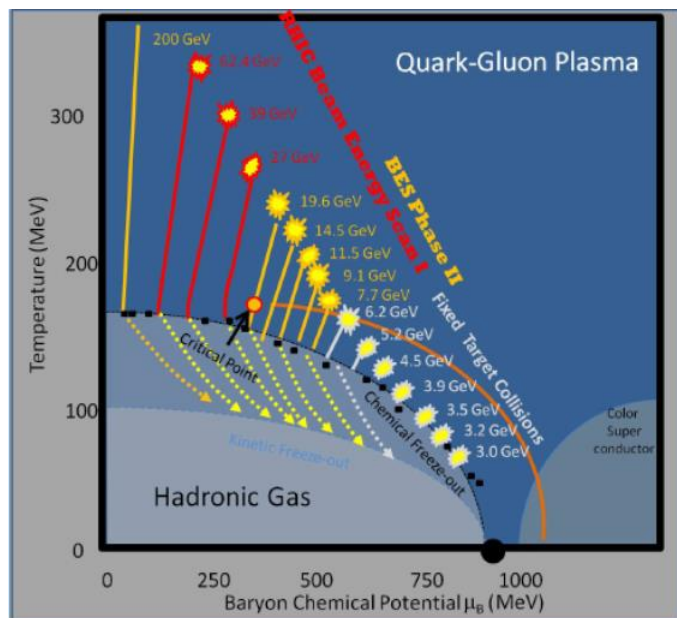

- Onset of deconfinement
- Chiral symmetry restoration
- 1st order phase transition
- Critical point
- Strange states of matter

Physical observables

- Rapidity dependence
- Di-lepton
- Directed flow
- Elliptic flow
- Fluctuations
- Hypernuclei

arXiv:1609.05102v

Physics Program for the STAR/CBM eTOF Upgrade - version 2.1

The STAR/CBM eTOF Group
(Dated: March 29, 2016)

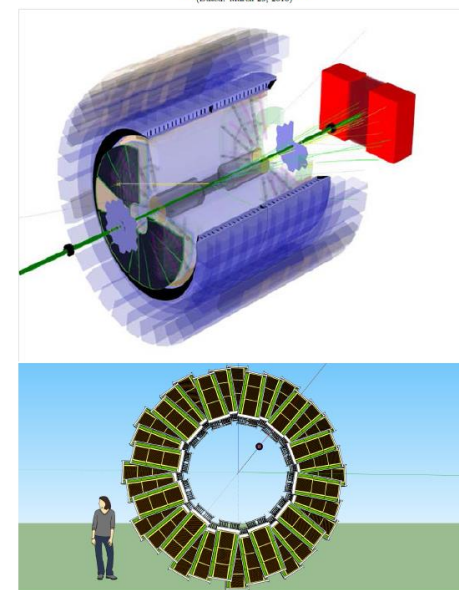

Ingo Deppner

CBM-STAR joint Workshop
Wuhan 23.09.2017



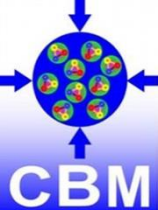

Beam Energy Scan phase II



Daniel Cebra
7/29/2015

BES phase II Proposal

μ_B Step size is
about 50 MeV

Collision Energies (GeV):	7.7	9.1	11.5	14.5	19.6
Chemical Potential (MeV):	420	370	315	260	205
Proposed Number of Events:	100	160	230	300	400

Fixed Target Program

- cms energies from 3 to 7.7 GeV
- Baryon chemical potential range from 420 MeV to 720 MeV
- Fixed target program not yet approved

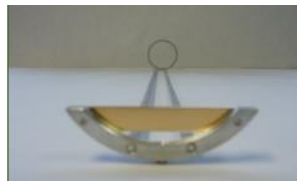

Collider Energy	Fixed-Target Energy	Single beam AGeV	Center-of-mass Rapidity	μ_B (MeV)
62.4	7.7	30.3	2.10	420
39	6.2	18.6	1.87	487
27	5.2	12.6	1.68	541
19.6	4.5	8.9	1.52	589
14.5	3.9	6.3	1.37	633
11.5	3.5	4.8	1.25	666
9.1	3.2	3.6	1.13	699
7.7	3.0	2.9	1.05	721



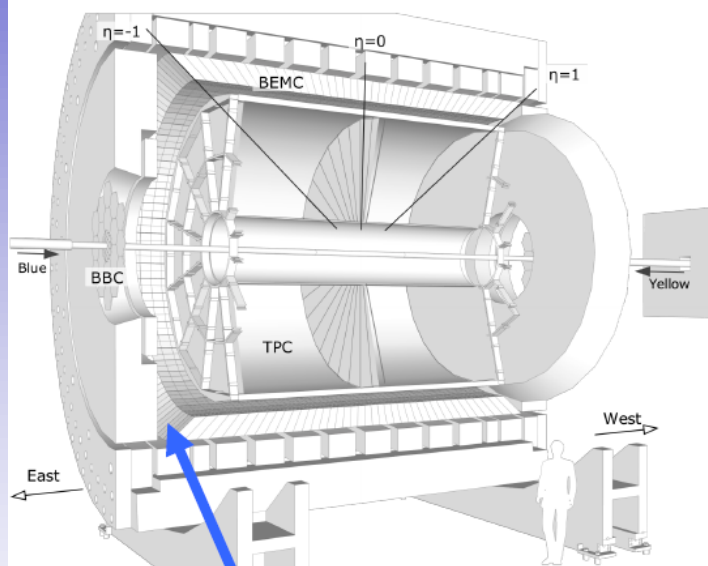

space for endcap TOF modules

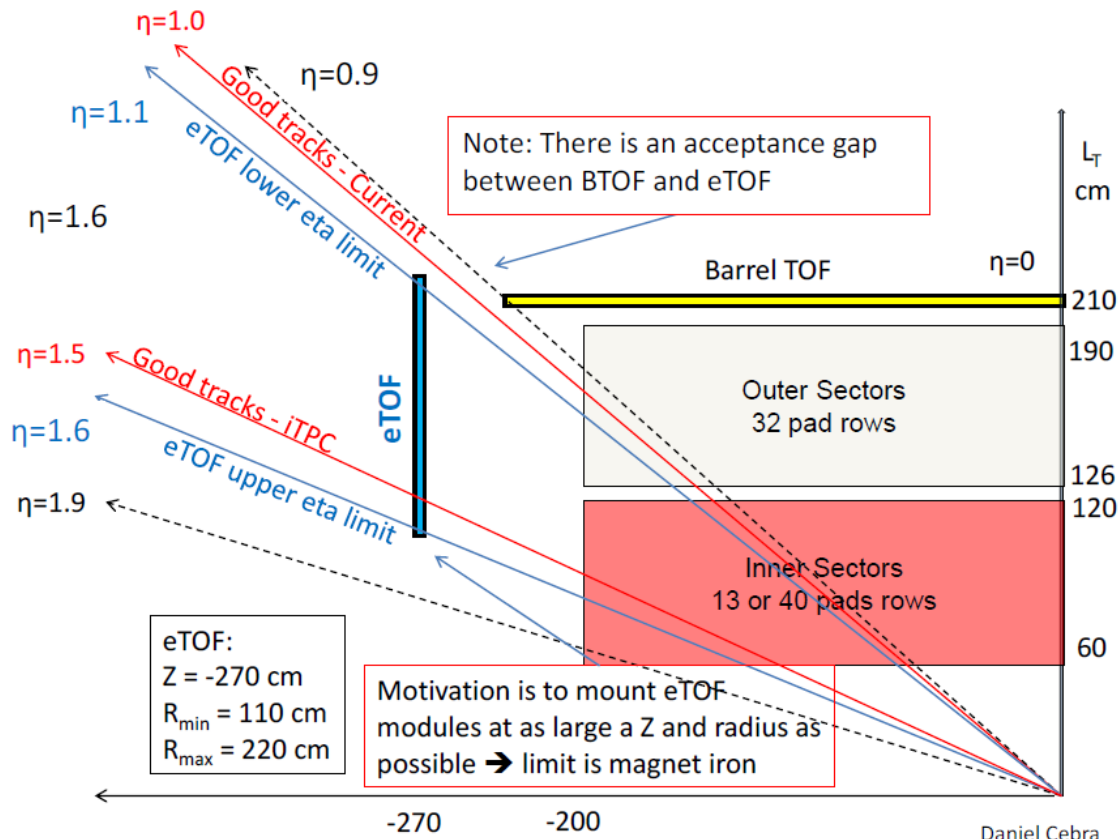



Acceptance in fixed target mode

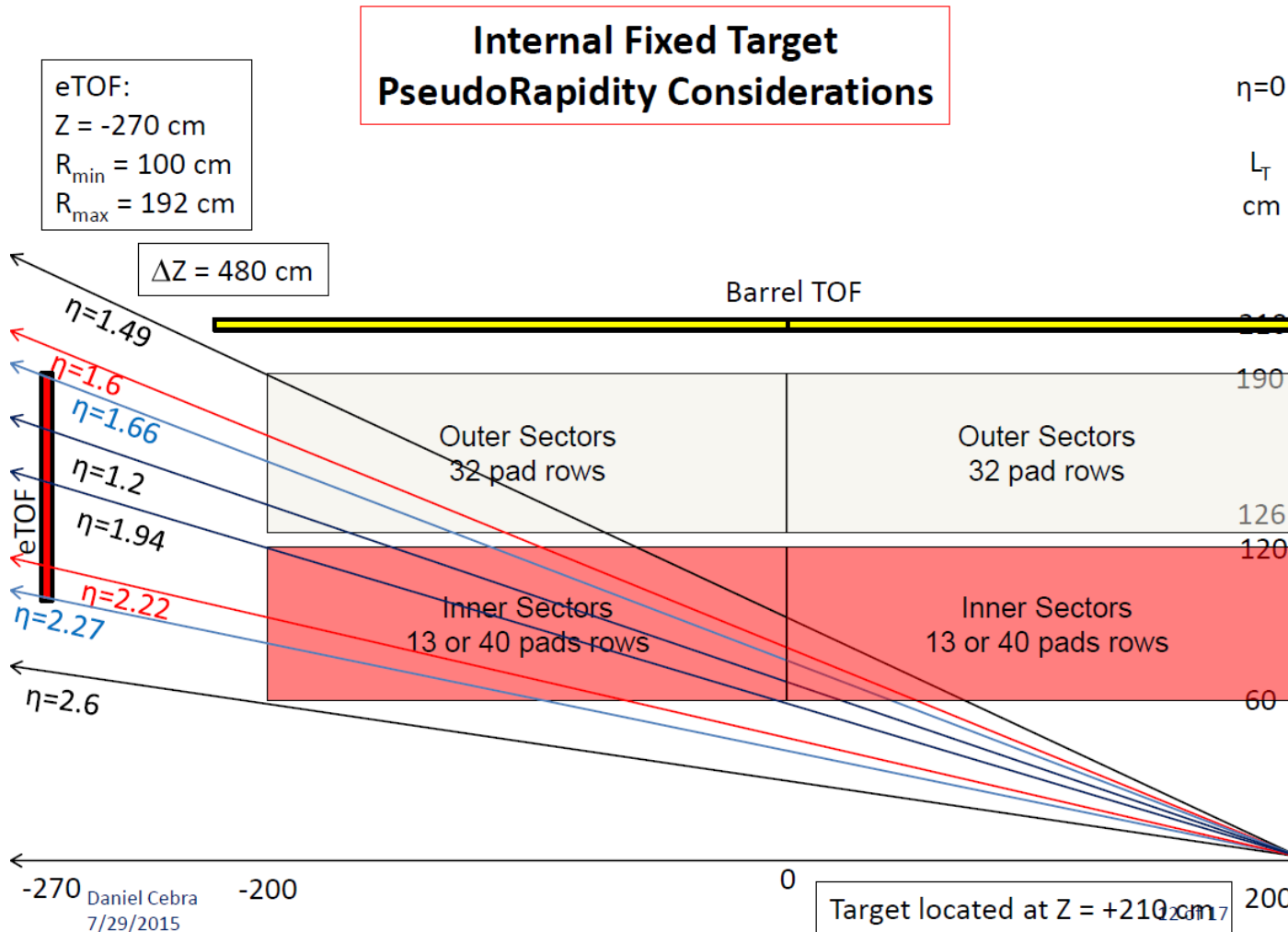

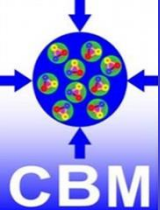

Acceptance in collider mode



- Pseudo rapidity range for eTOF $1.05 \leq \eta \leq 1.5$ (FXT: $1.66 \leq \eta \leq 2.27$)
- Low p_t limit - from track length of the TPC (multiple scattering)
- High p_t limit – time resolution of the TOF system

collider

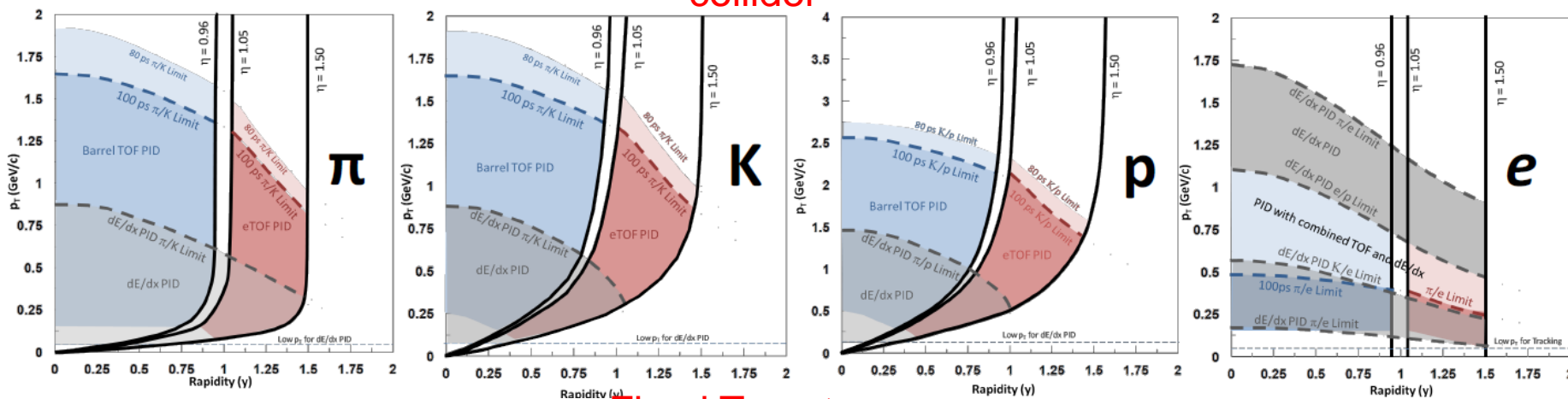

Fixed Target

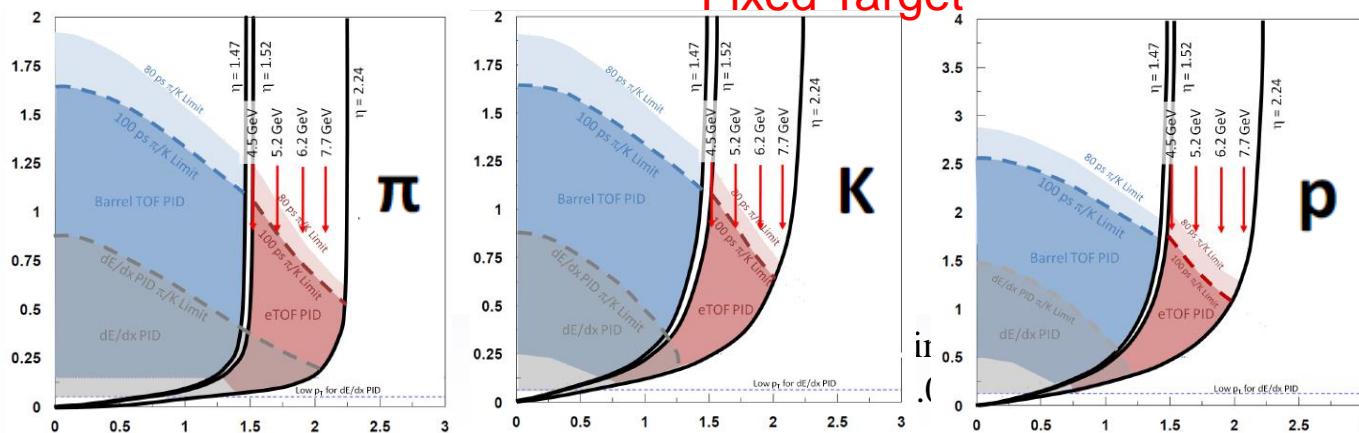

arXiv:1609.05102v





The eTOF wheel

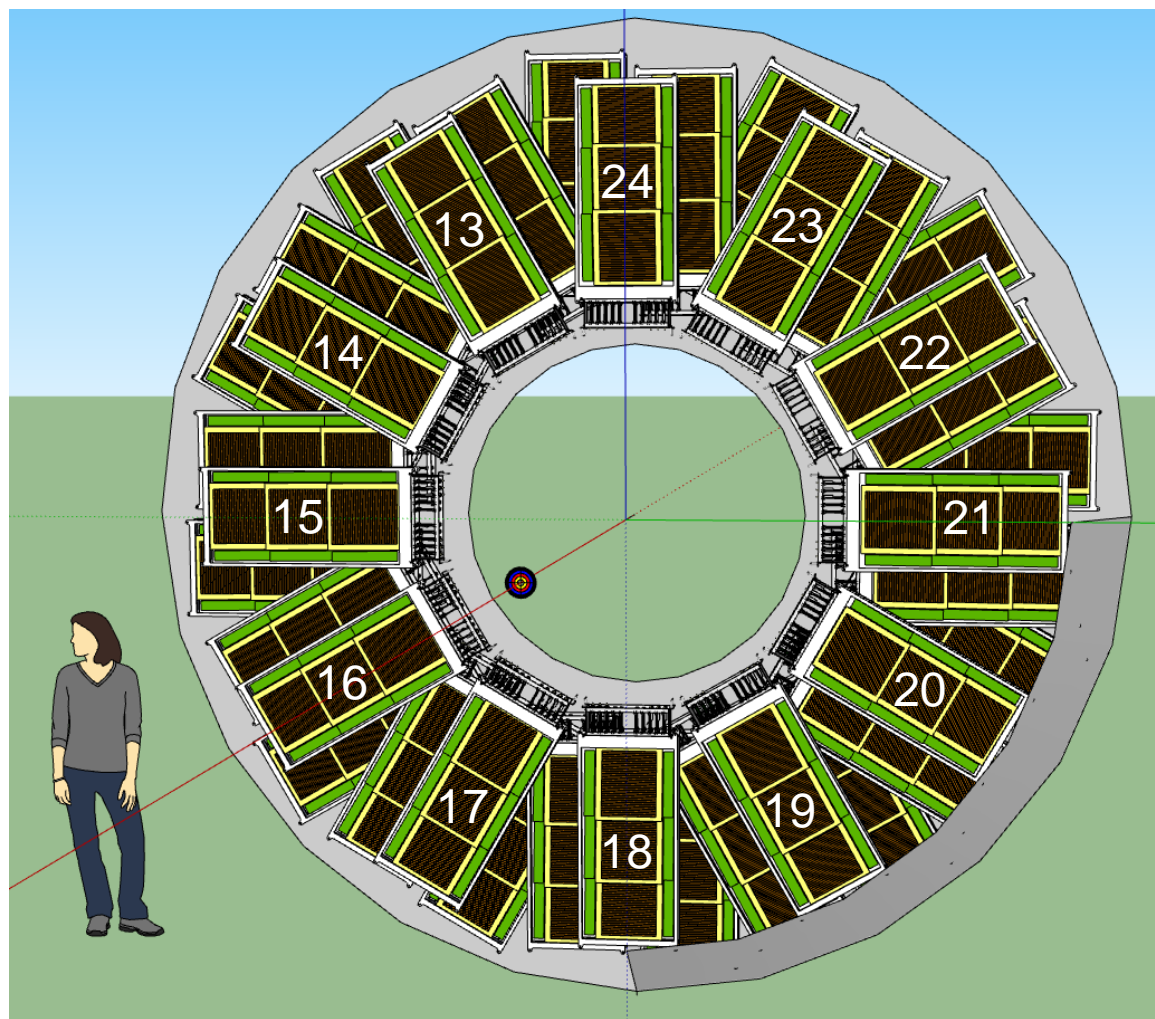
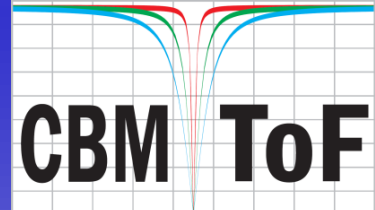

A conceptual design

- 36 modules
- 3 layers
- 12 sectors
- 6912 channels

- Sector counting matches the TPC sectors

- Total depth about 14.2" (36 cm)



- 3 MRPCs (MRPC3a/b) – tilted by $\approx 10^\circ$
- 32 strips/MRPC with a pitch of 1 cm
- 27 cm strip length
- Active area about 92 cm x 27 cm
- 192 read out channels



Preamplifier PADI boards

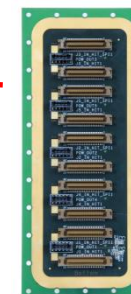
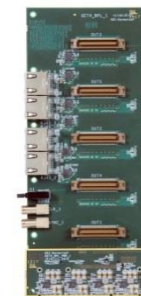
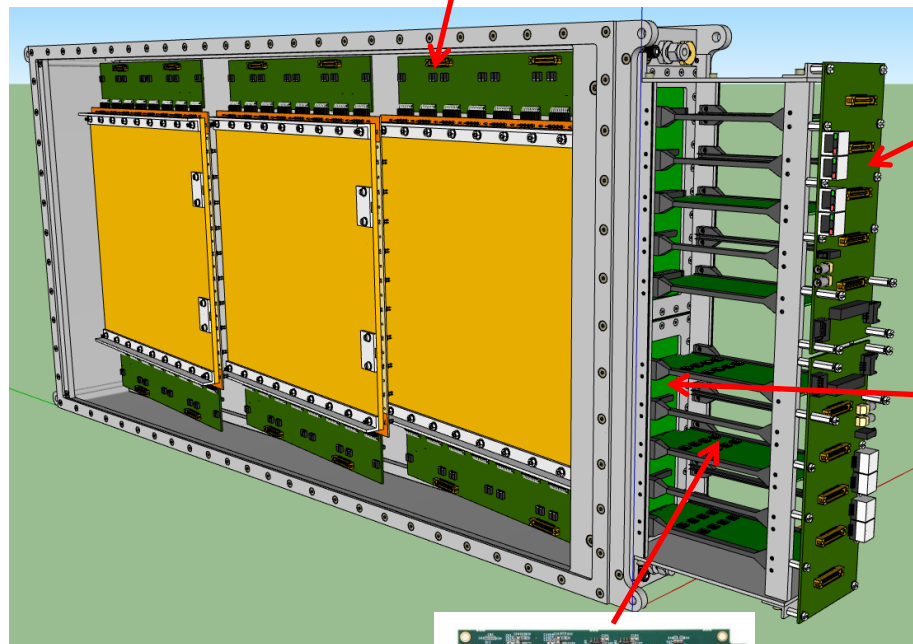

TDC GET4 boards

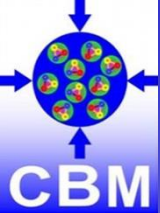

Mounting scheme

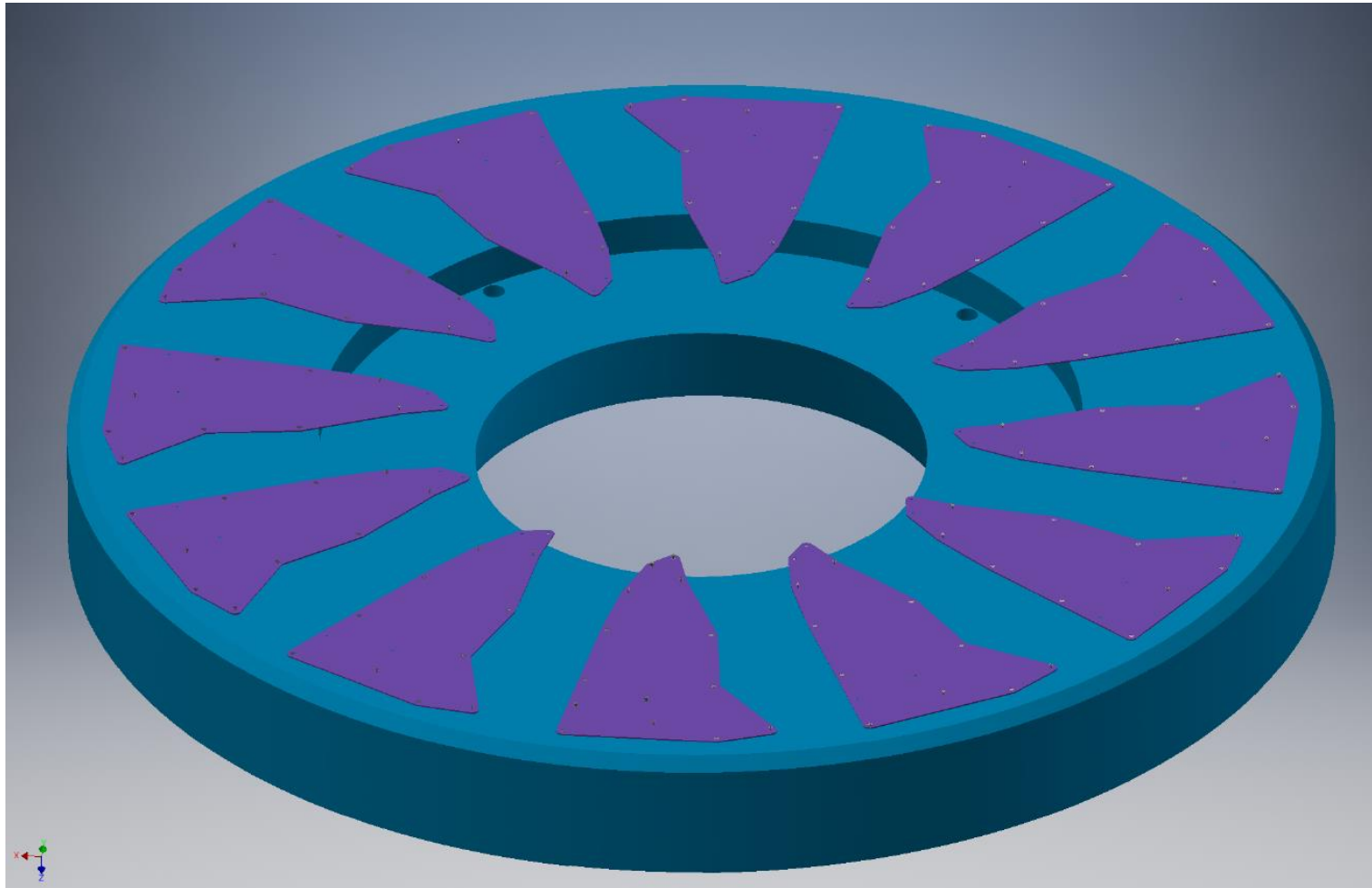

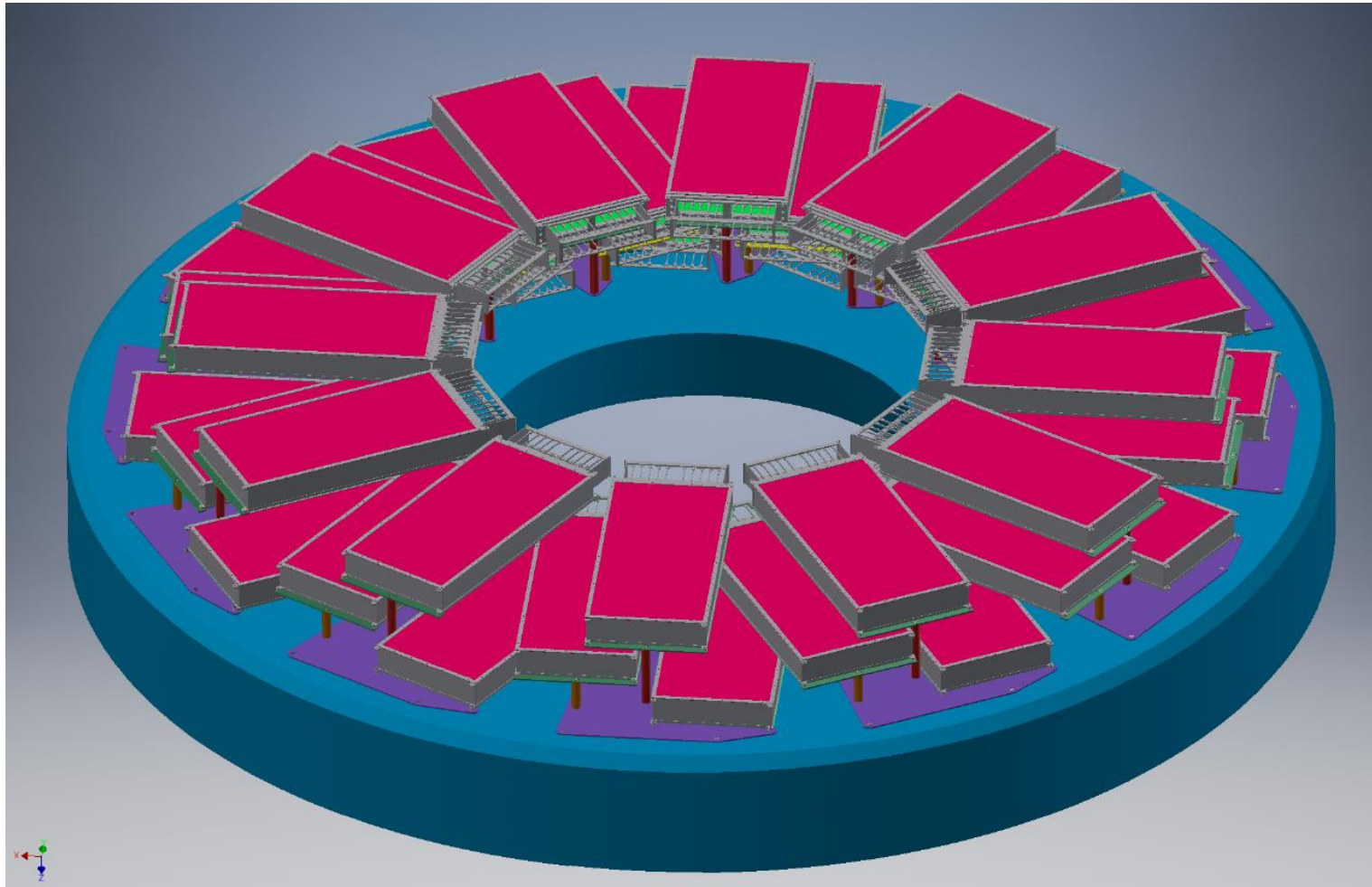

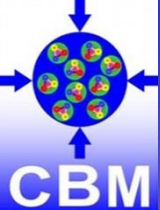

eTOF geometry in CBM ROOT

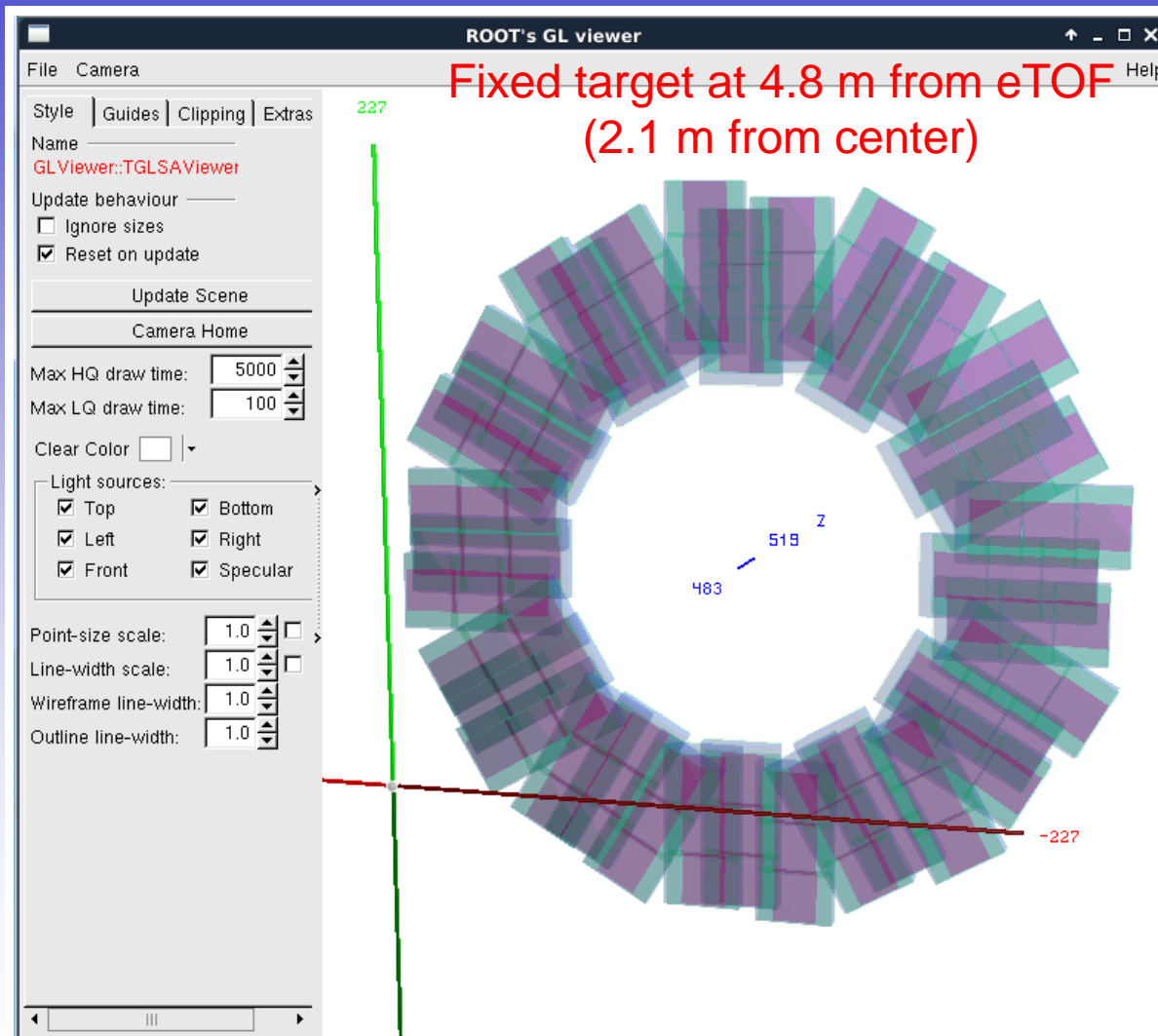

- MRPC
 - Active gas
 - Glass
- Electronics
- Aluminum box



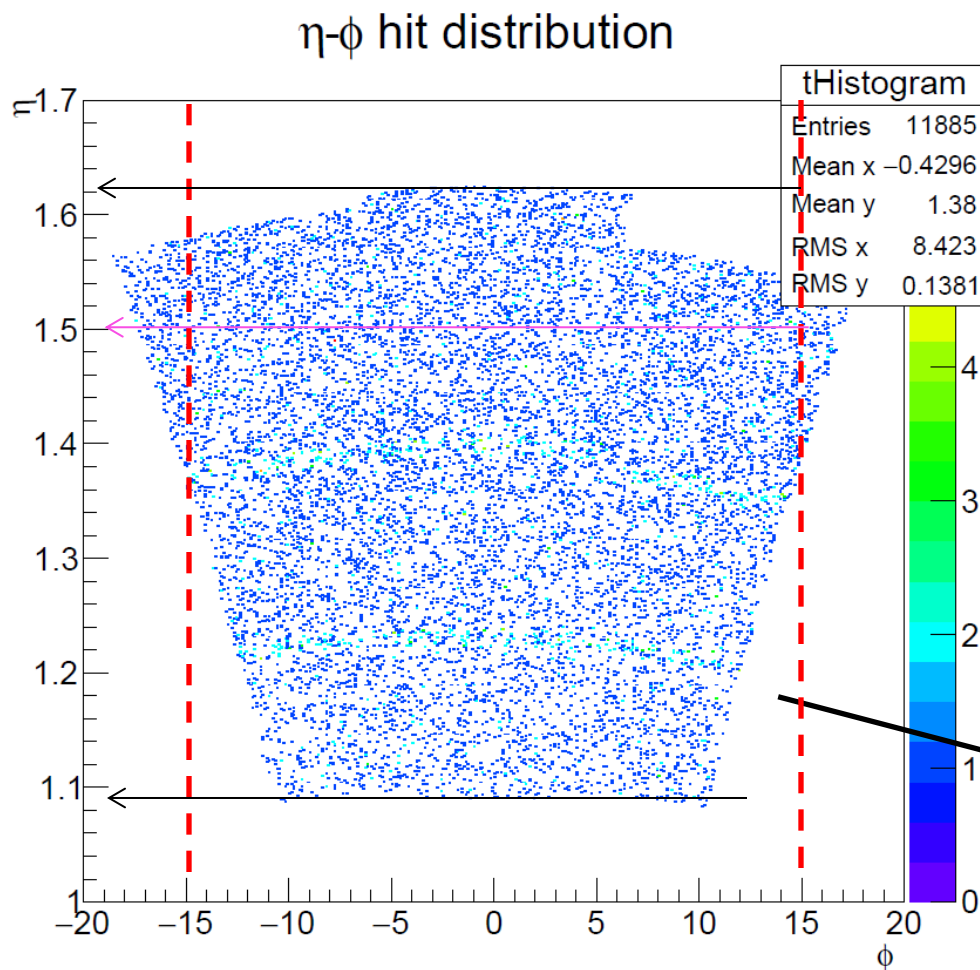

Collider mode

Interaction point 2.7 m

$1.09 < \eta < 1.62$

Good tracks - iTPC

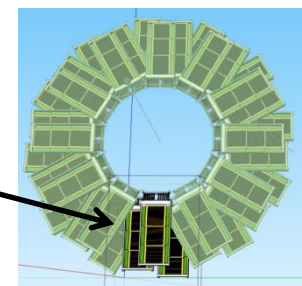

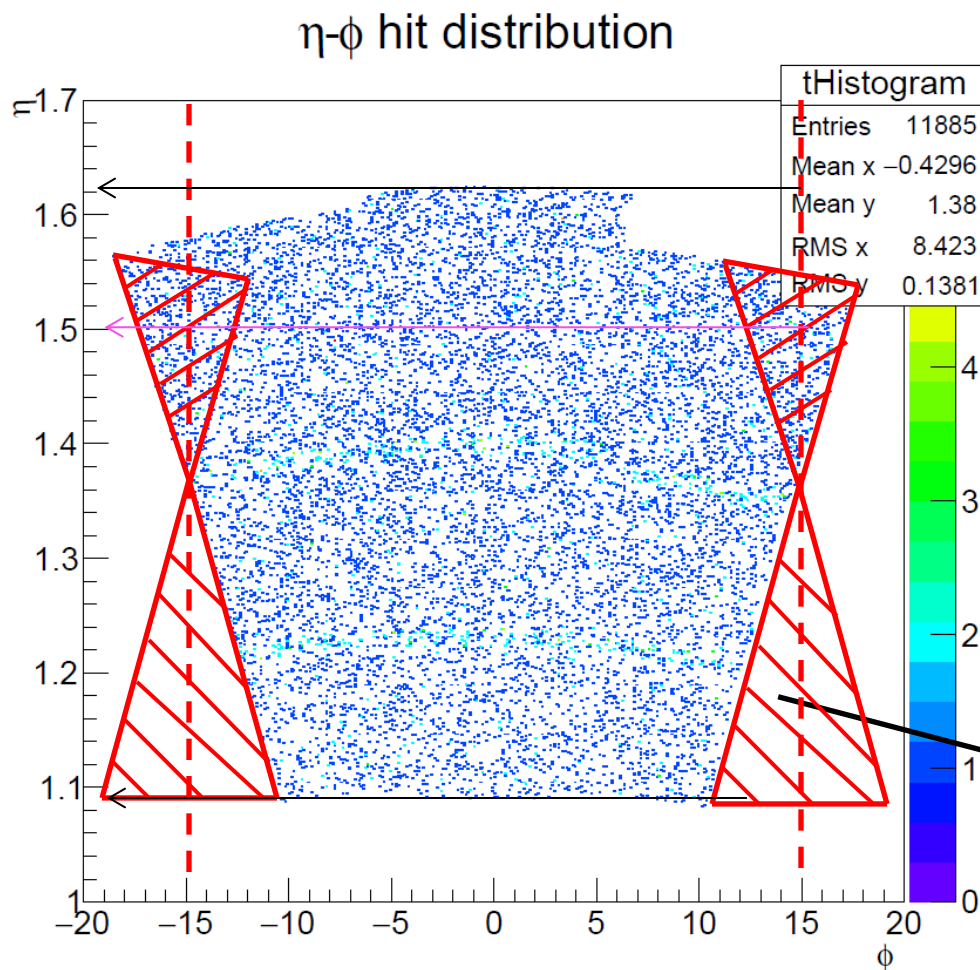

Collider mode

Interaction point 2.7 m

$1.09 < \eta < 1.62$

Good tracks - iTPC

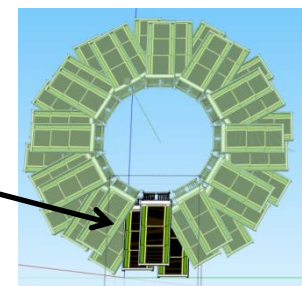

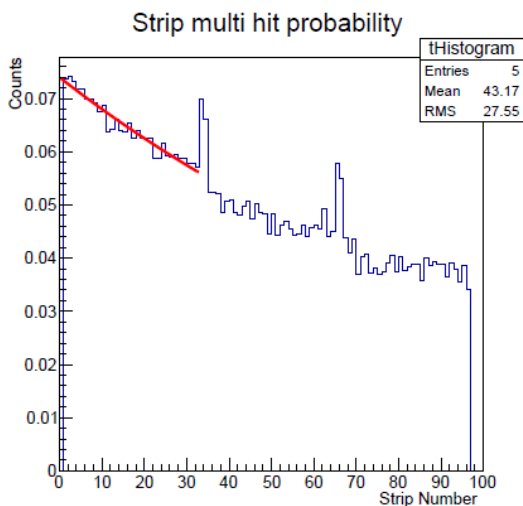
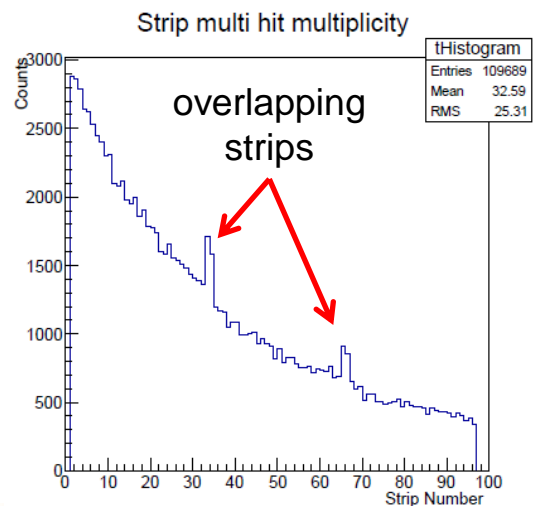
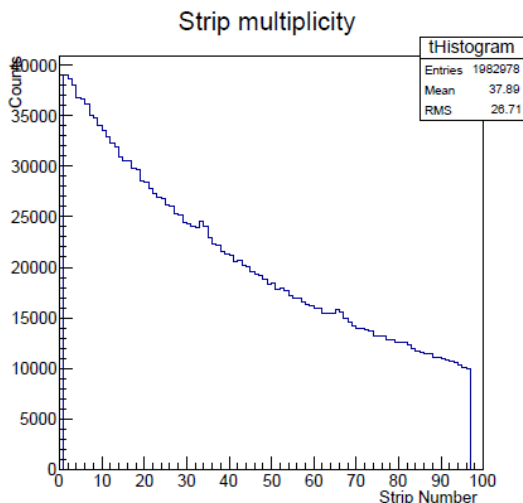
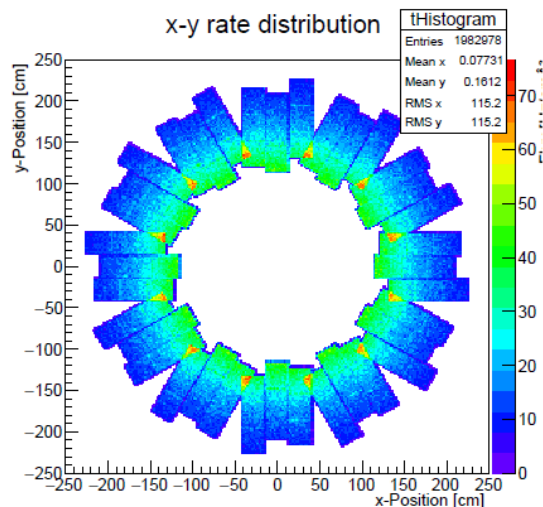

All particles

- Beam energy **25 AGeV**
- Interaction rate 10kHz (2kHz recording rate)
- Fixed target position 4.8 m
- Particle flux $< 45\text{Hz}/\text{cm}^2$
- Multi-hit probability $< 7.4\%$

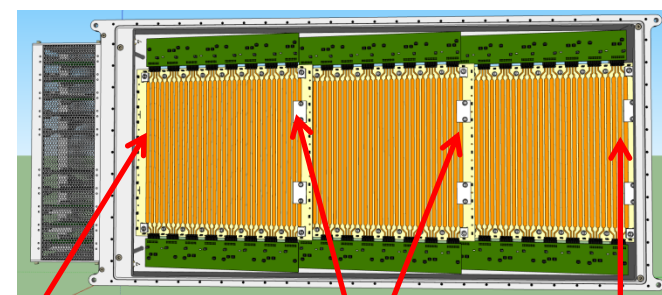

Strip 1

Strip 96

overlapping strips

Open module

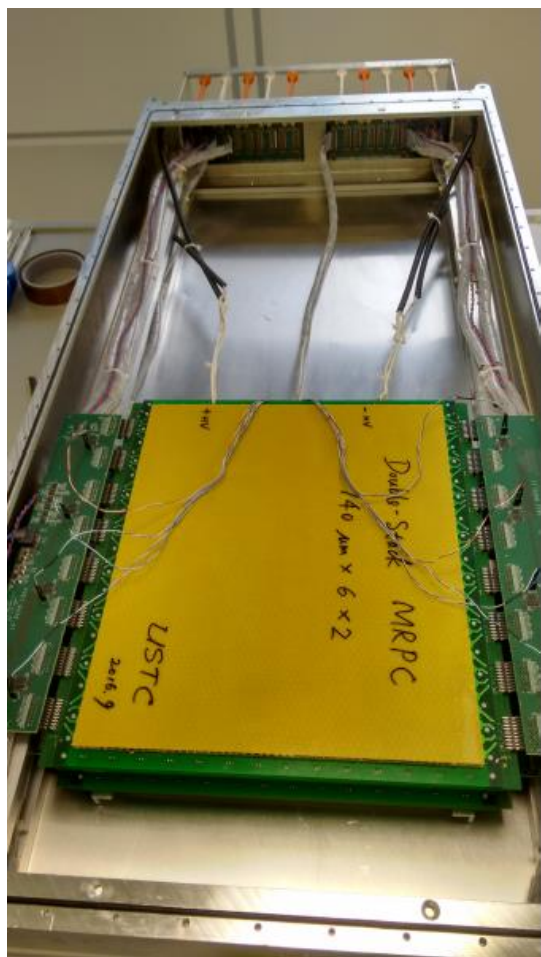

Module fixed at the pole-tip

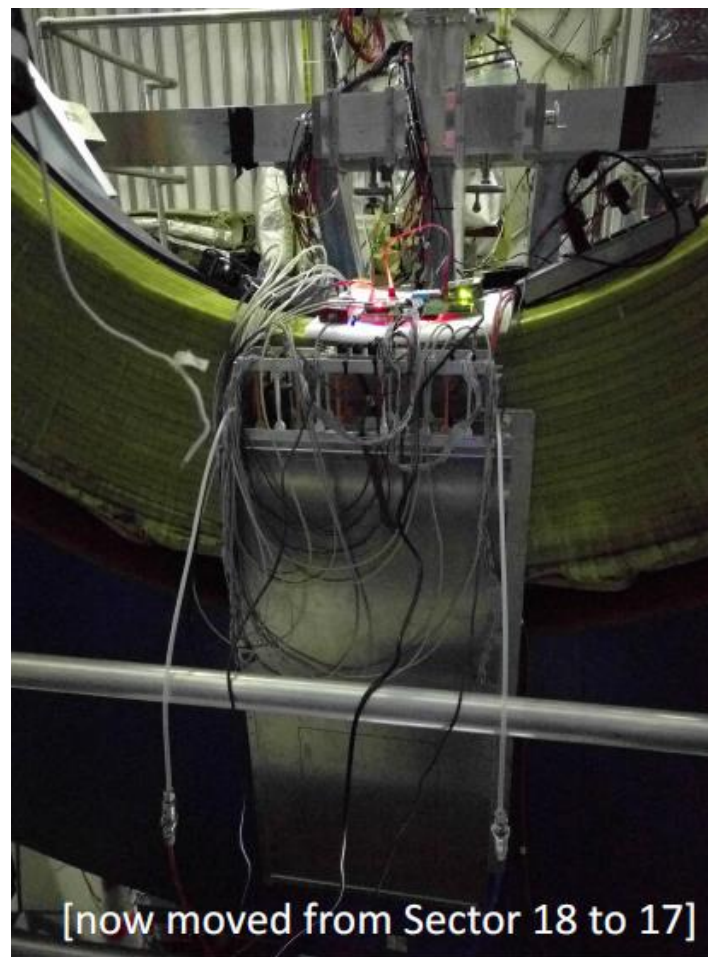

Successes

Interface to STAR TCD runs without any dropped tokens, or any hangups.

Interface to barrel TOF 40 MHz clock (TOCK) is stable.

Interface to STAR event builder successfully commissioned. There are still occasional DAQ errors in some runs, but STAR data taking is smooth.

Collected ~64M production trigger events with eTOF.

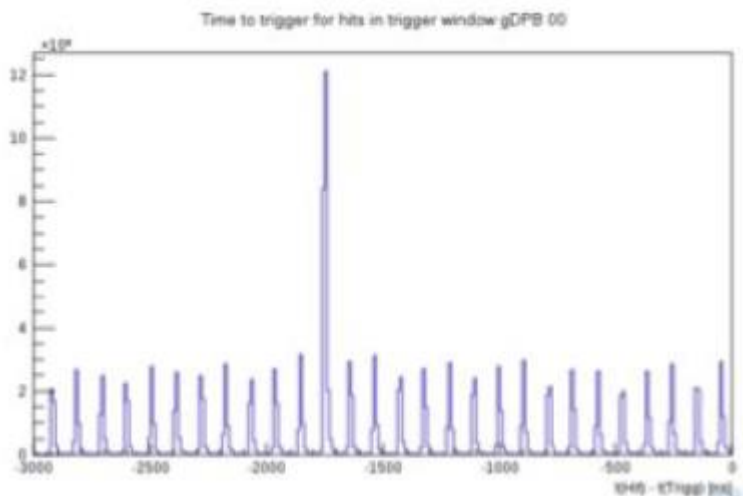

Problems

During APEX on March 22, eTOF saw ~ 4 kHz/cm², ~ 20 times normal. After this, the PADI preamps functioned as if they were set to the maximum threshold, which could not be changed. The hit rate dropped by a factor of ~ 100 .

Both MRPC detectors failed -- no longer hold HV. The first after a week and the second on April 7. They will be returned to Heidelberg for study after the run.

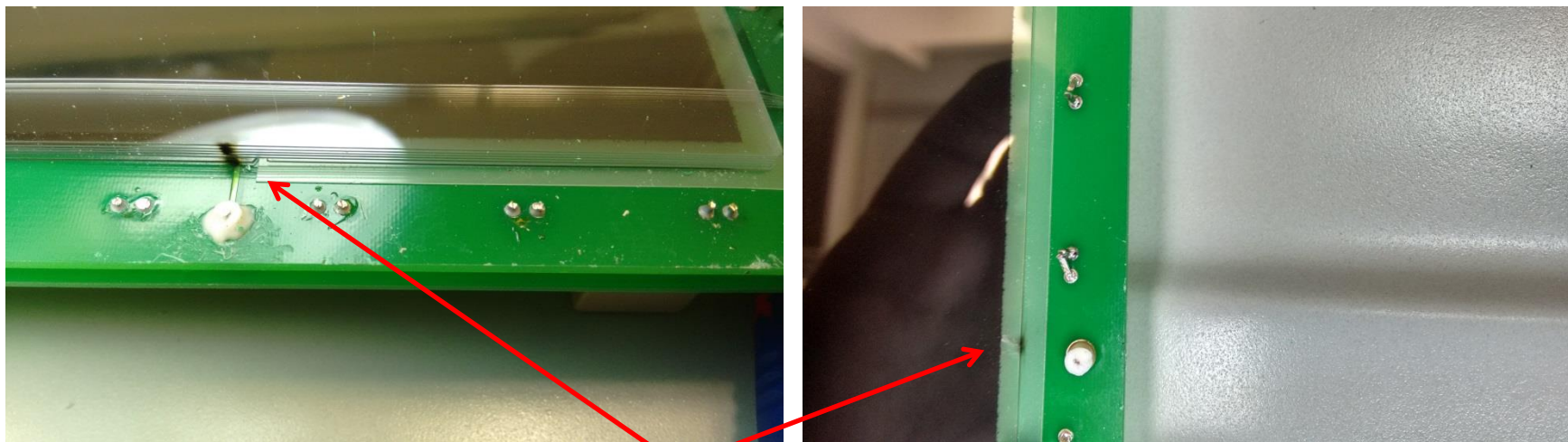

HV damage

One full sector

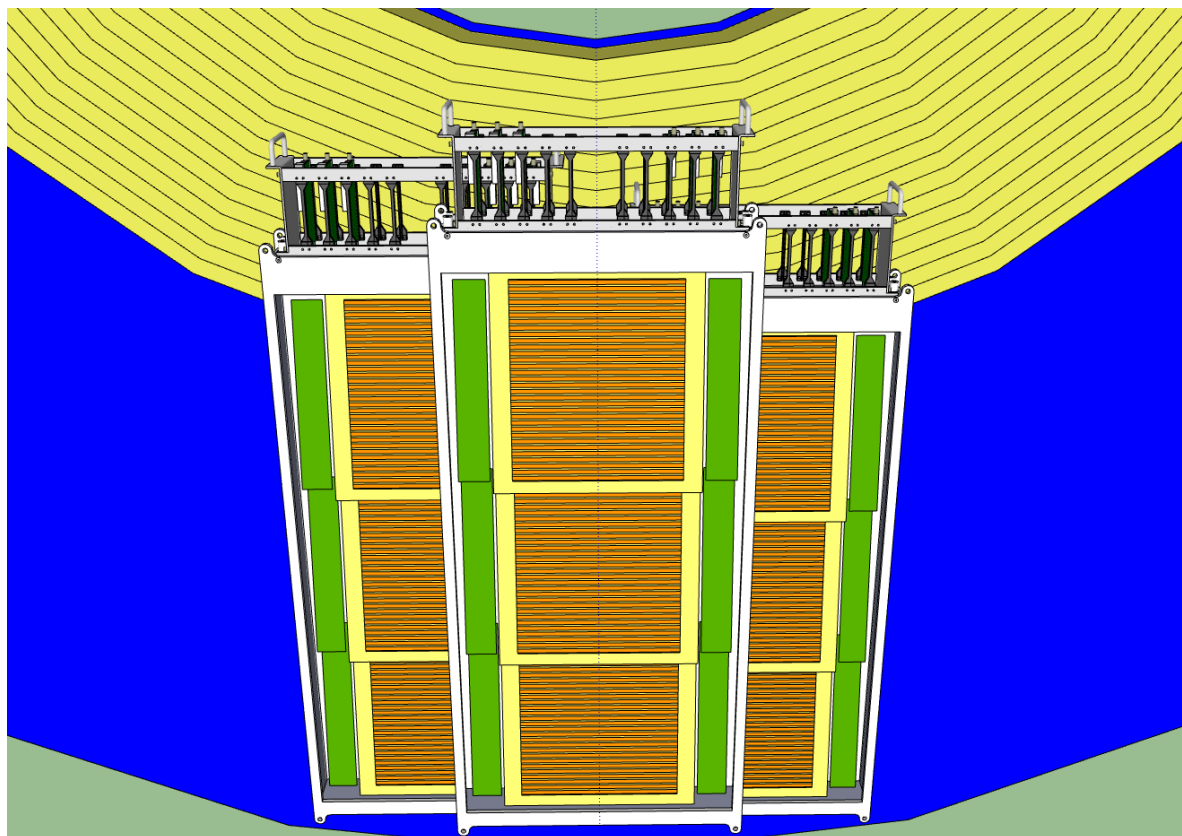

- 6 MRPCs with float glass (USTC)
- 3 MRPCs with low resistive glass (Tsinghua Univ.)
- Review readiness report March 2017

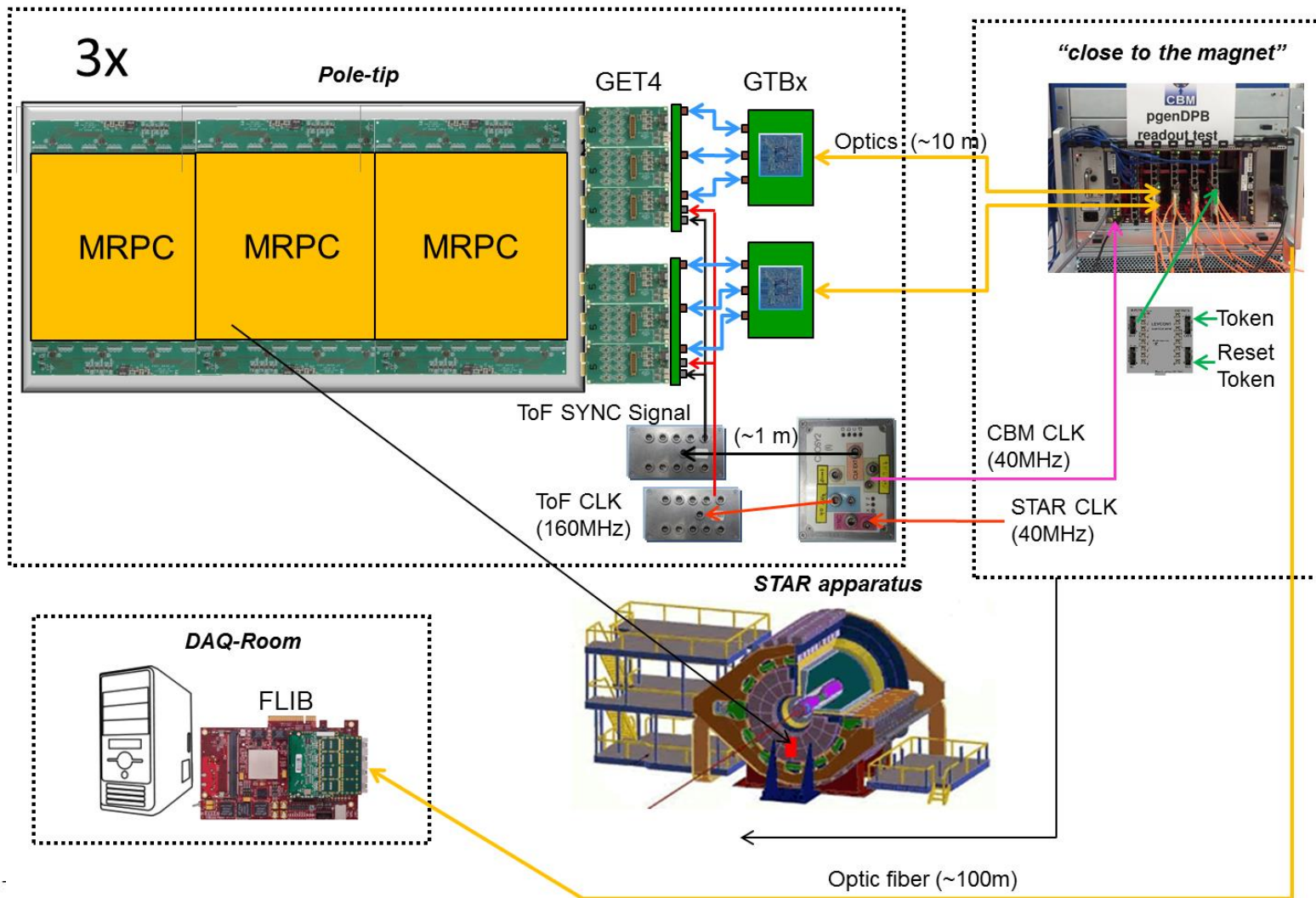

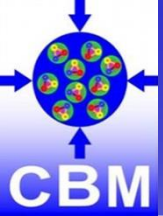

Setup in Run 2018

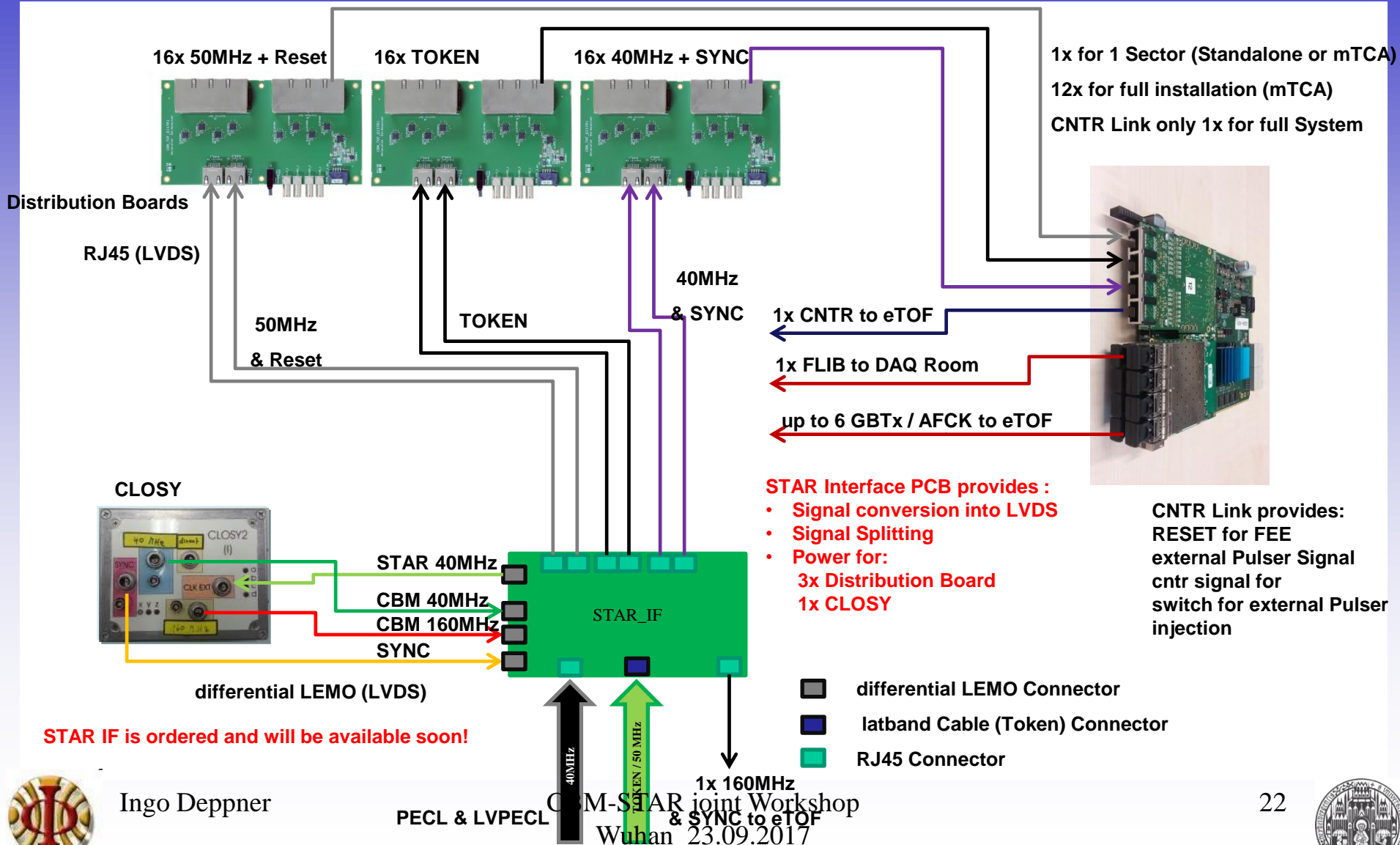

Ingo Deppner



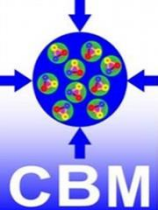

Status and time line for Run 18

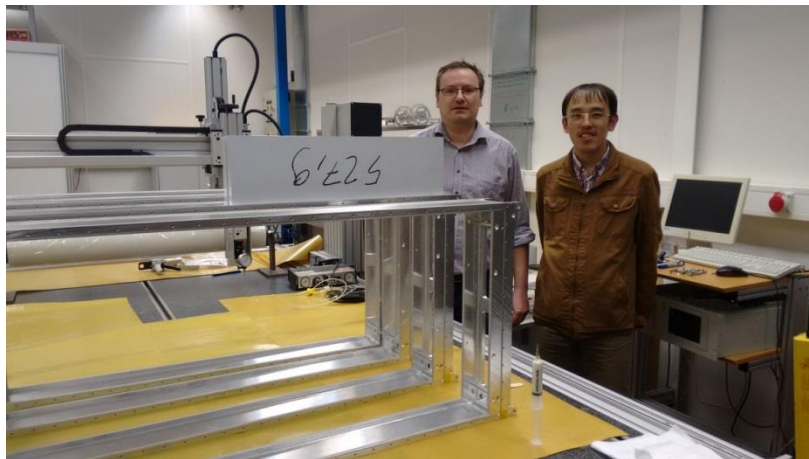

Status

- Production of 4 boxes ready
- 3 MRPC3a send to HD yesterday
- 10 MRPC3b available end of October
- PADI FEE available for full wheel
- GET4 FEE available for one sector
- CROB available end of September, redesign for GBTx directly on Backplane ongoing
- AFCKs with FM-S18 and RJ45 ADDON are available
- mTCA Crate including the needed Infrastructure is ordered
- PC and needed Hardware ordered

Time line

- | | |
|-------------------|------------------|
| • Testing modules | Nov. – Dec. 2017 |
| • Installation | Jan 2018 |
| • Commissioning | Jan. – Feb. 2018 |
| • Running | Mar. – Jun. 2018 |



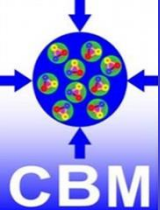

Cosmic test stand in HD

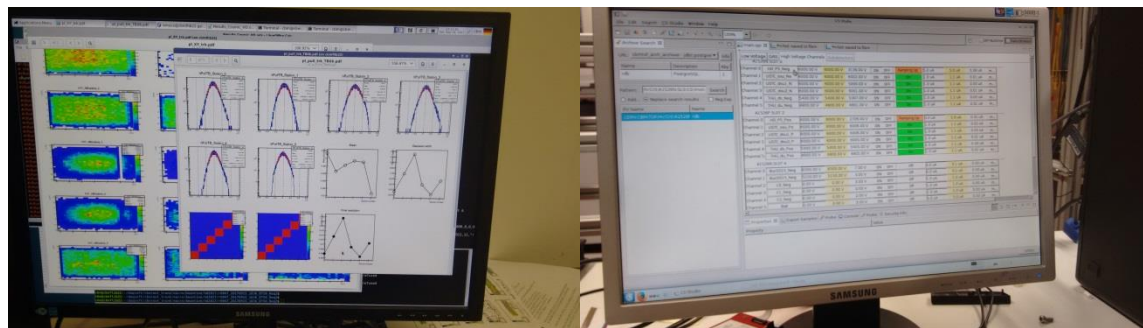
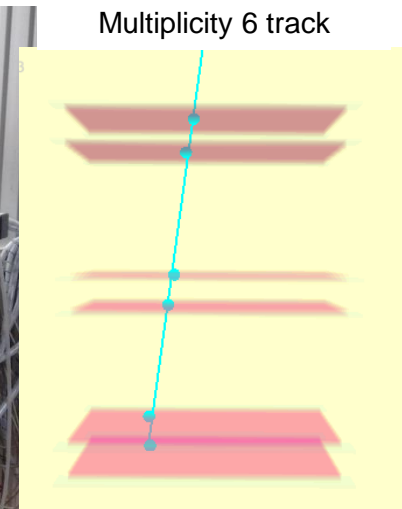
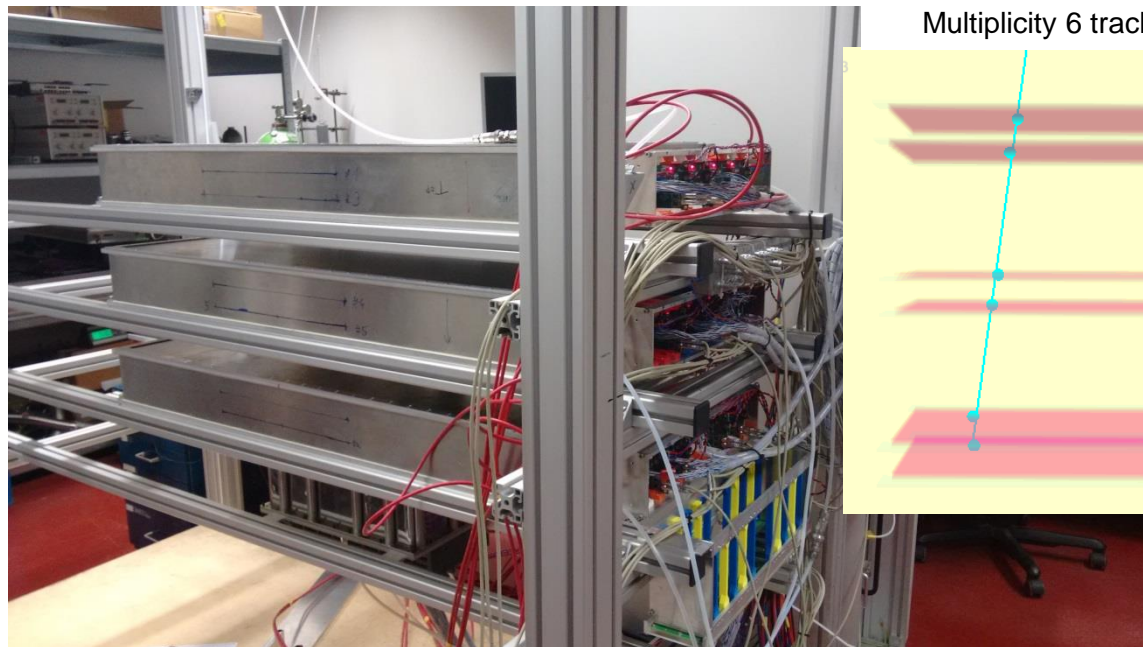

Ingo Deppner

CBM-STAR joint Workshop
Wuhan 23.09.2017

24





Preliminary test results



MRPC3a

32 cm x 27 cm active area
 2 x 4 gaps
 250 μm gap size
 low resistive glass
 0.7 mm glass thickness

Gas Mixture:

95% Freon, 5% iso-Butane

Efficiency of 921

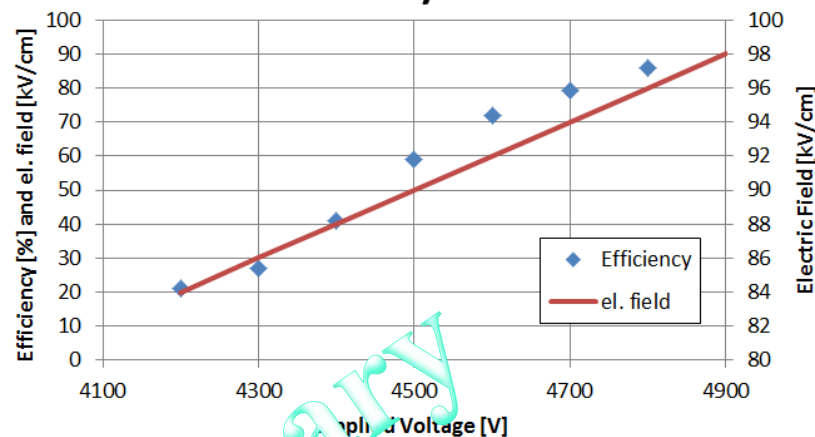

Time resolution of 921

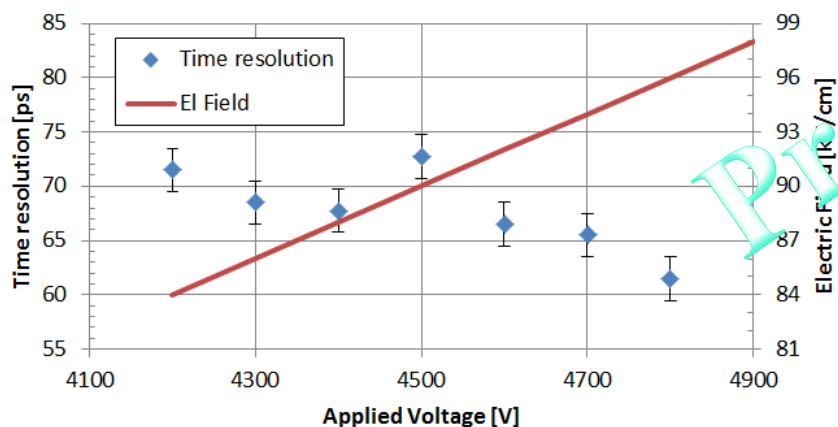

Dark rate of 921

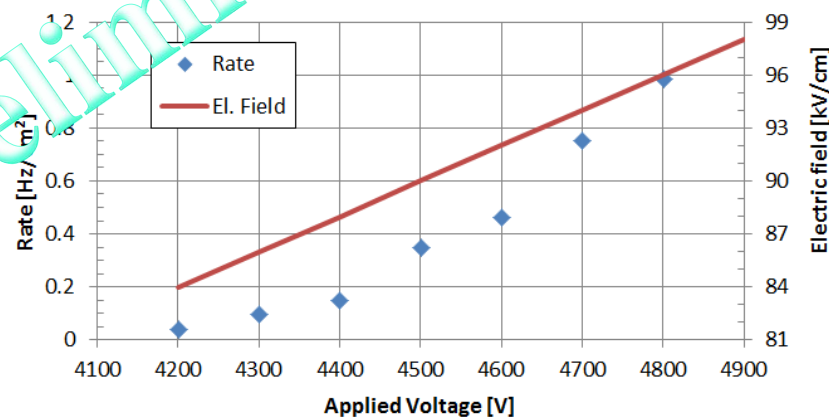



Preliminary test results



MRPC3b

32 cm x 27 cm active area

2 x 5 gaps

230 μm gap size

Float glass

280 μm glass thickness

Gas Mixture:

95% Freon, 5% iso-Butane

Counter time resolution
about 60 ps

Efficiency 94%

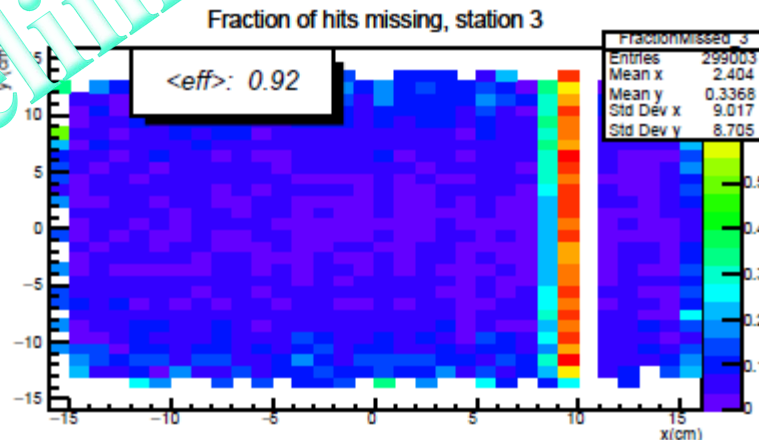
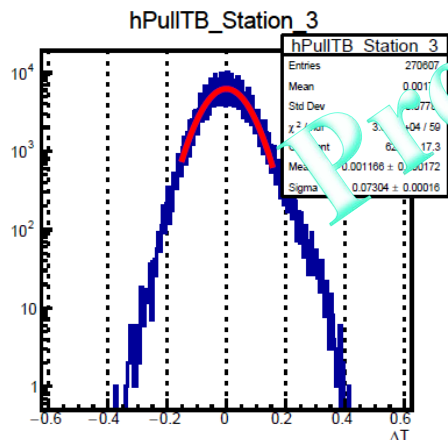
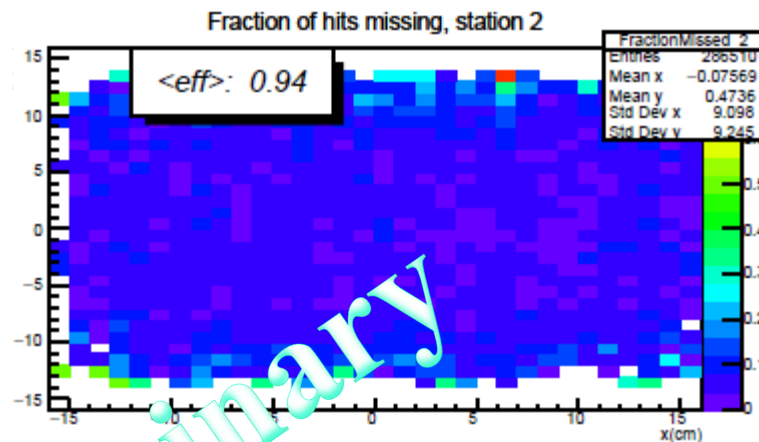
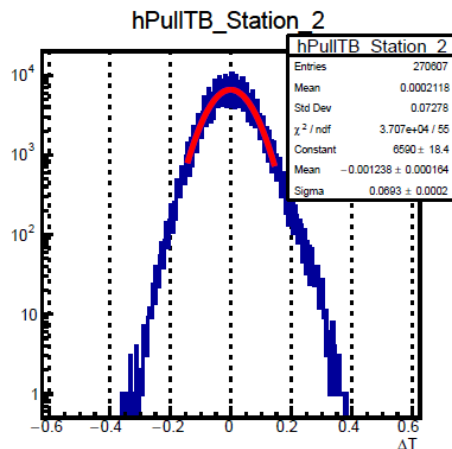

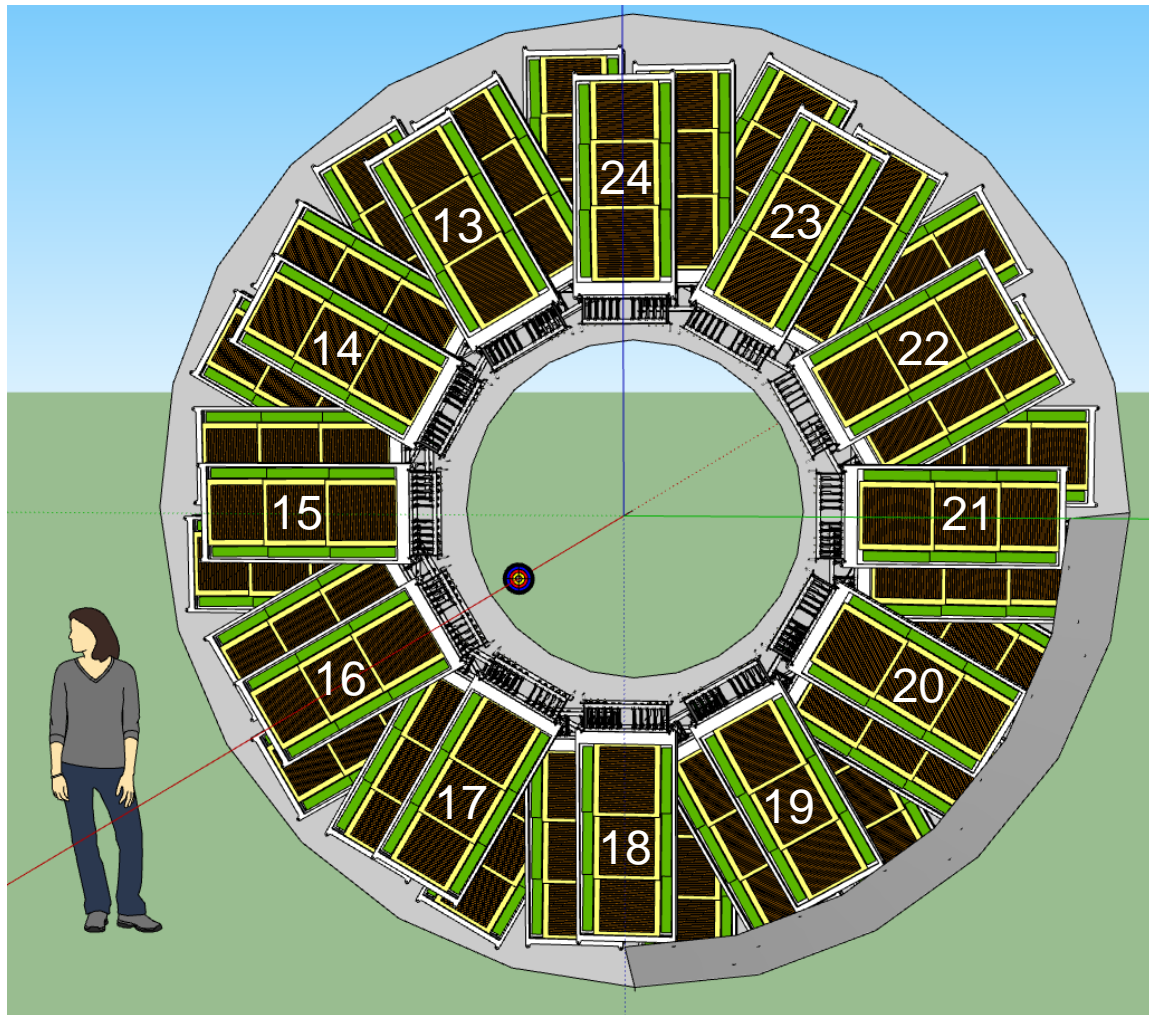

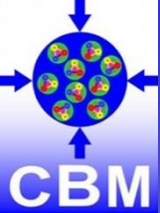

Project milestones



- ✓ December 2015 submit the physics proposal to GSI and BNL for approval
- ✓ October 2016 shipping a real size module to BNL and installing it on the east side pole of STAR
- ✓ Feb. 2017 1st system integration test with one module by participating in the Run17 beam time in STAR
- Jan 2018 shipping and installation of one sector
- Feb. 2018 2nd system integration test with one sector by participating in the Run18 beam time in STAR
- Fall 2018 shipping all 33 modules including infrastructure (gas system, LV-, HV-power supply) to BNL
- Fall 2018 Installation and commissioning
- Feb 2019/2020 Start of the BES II campaign
- Summer 2021 Decommissioning and shipping of all modules including infrastructure to FAIR



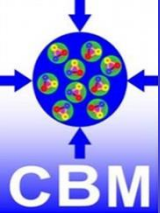

Summary



- **eTOF offers unique opportunities within the next 3 years**
 - Hardware performance test
 - counter performance
 - DAQ stability
 - Software development environment
 - calibration
 - PID methods
 - Physics analysis experience (with eTOF data)
 - flow
 - fluctuations
 - strange resonances
- **eTOF can be realized as part of the CBM FAIR phase 0 program**
- **eTOF project on a good track**
- **New people and contributions are highly welcome**





Thank you for your attention



Special thanks goes to
Geary Epply



eTOF participating institutions

CBM: Heidelberg, Darmstadt, USTC, CCNU, Tsinghua

STAR: BNL, Rice, UC Davis, Kent State, LBNL



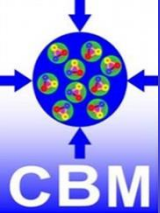

Backup



Backup Slides



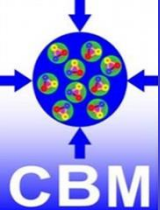

Letter of interest



draft: September 22, 2015

Letter of Interest

Introduction

The CBM collaboration institutions: Heidelberg, Darmstadt, Tsinghua, CCNU, and USTC and the STAR collaboration are interested in installing, commissioning, and operating a "wheel" of CBM TOF detectors mounted on the inside face of the STAR east pole tip, for the RHIC run periods in 2019-2020. This endcap TOF (time-of-flight) detector would extend STAR's particle identification (PID) in the intermediate momentum range to at least η of -1.5. The installation would benefit CBM by providing a large-scale integration test of the CBM TOF system, including PID and calibration of the detectors, prior to the installation in CBM and the start of

⋮

authorship and manpower contributions. We anticipate that the physics topics will be expanded into a physics proposal and presented to BNL for approval and to GSI for endorsement by December 2015. The equipment provided by CBM will be decommissioned and prepared for return to CBM following the 2020 RHIC run.



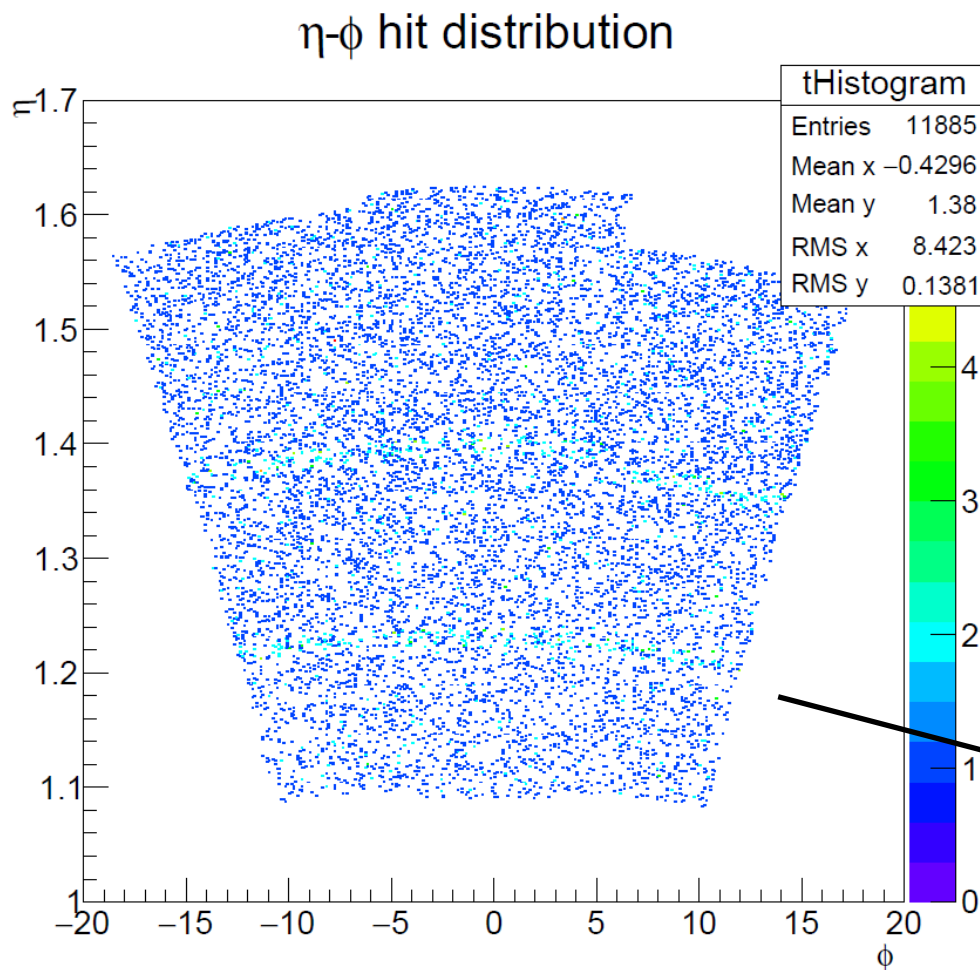

Collider mode

Interaction point 2.7 m

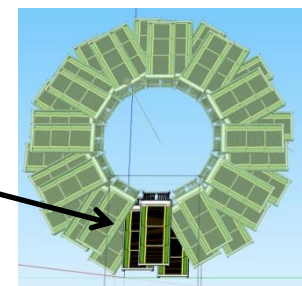

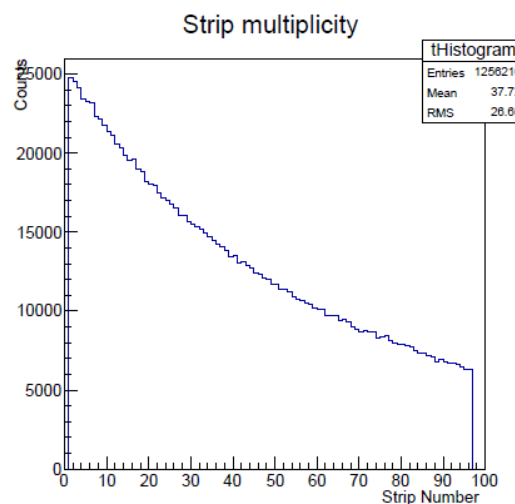
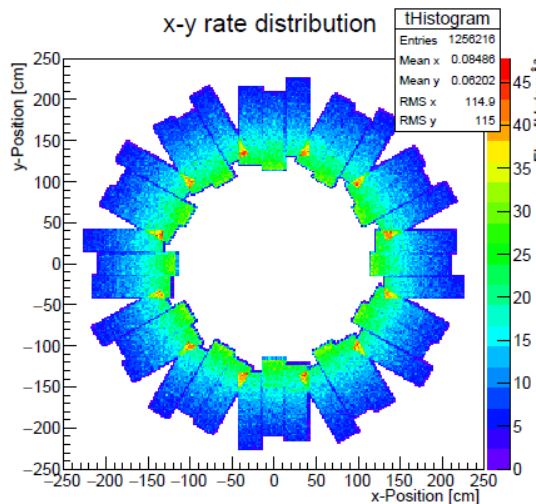

Primary particles

- Beam energy **25 AGeV**
- Interaction rate 10kHz (2kHz recording rate)
- Particle flux $< 25 \text{ Hz/cm}^2$
- Multi-hit rate $< 3.6 \%$

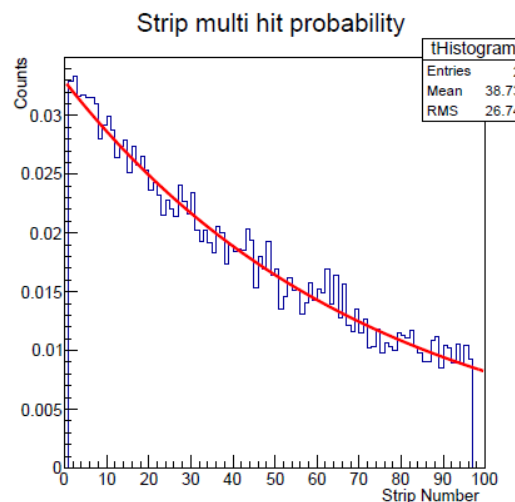
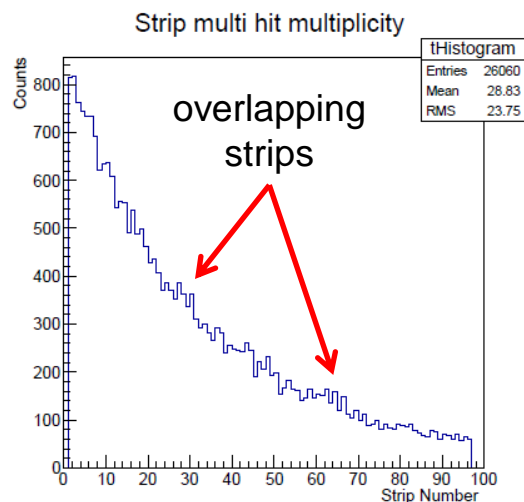

Spatial double hits distribution

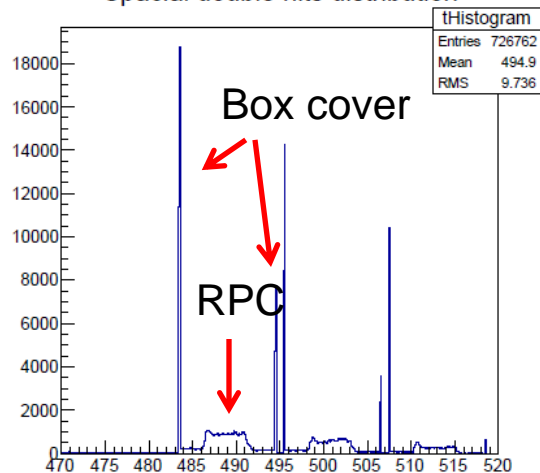

x-y secondary source

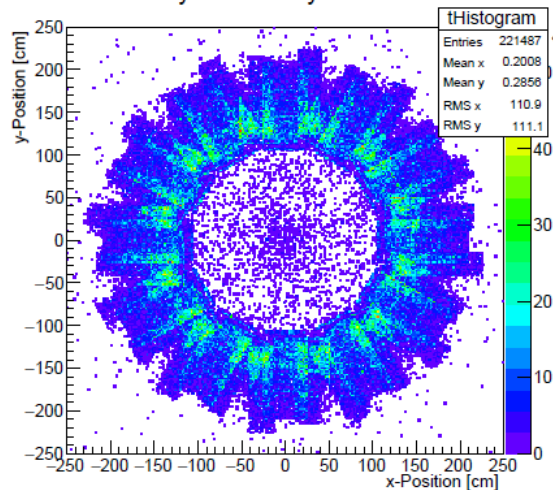

Secondary particles

- Beam energy **25 AGeV**
- Interaction rate 10kHz (2kHz recording rate)
- Majority of secondary's are produced in the box cover

Particle abundance

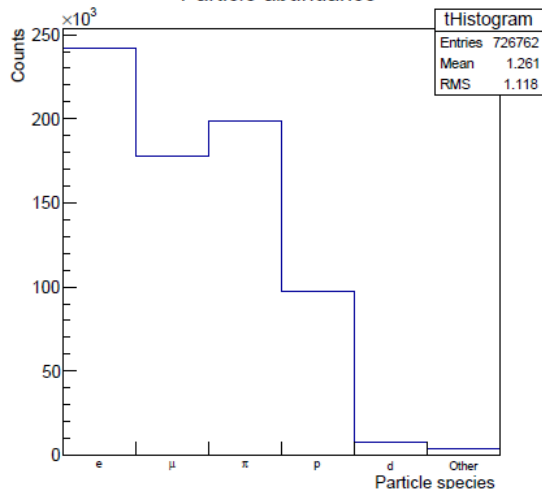



Rate and multi-hit

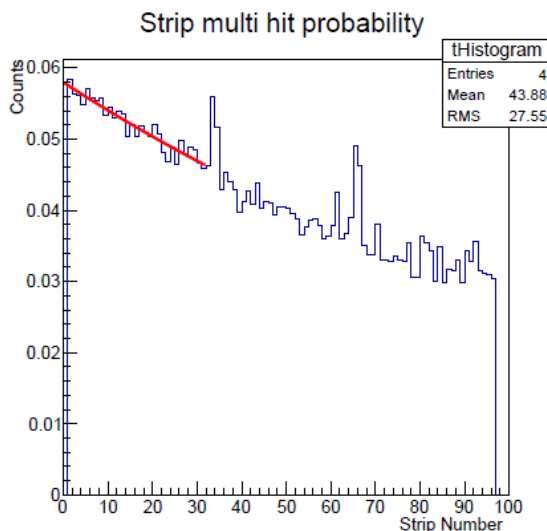
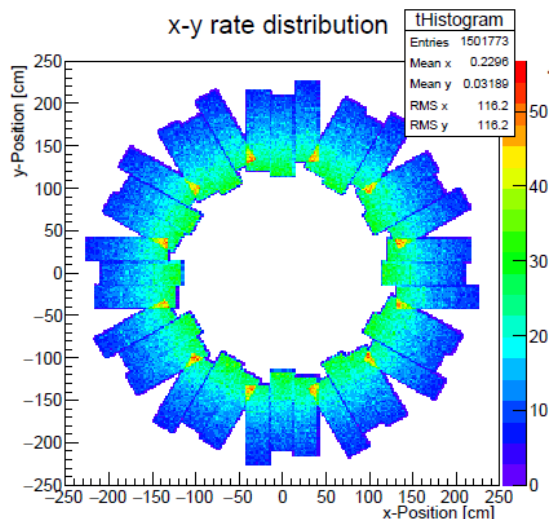

All particles

- Beam energy **10 AGeV**
- Interaction rate 10kHz (2kHz recording rate)
- Fix target position 4.8 m
- Particle flux $< 30\text{Hz/cm}^2$
- Multi-hit rate $< 5.8\%$

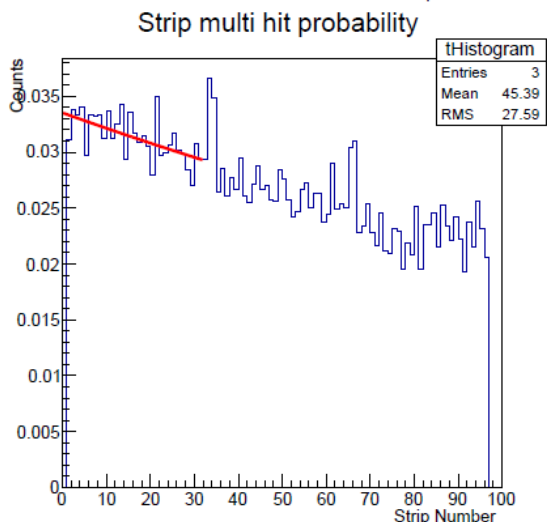
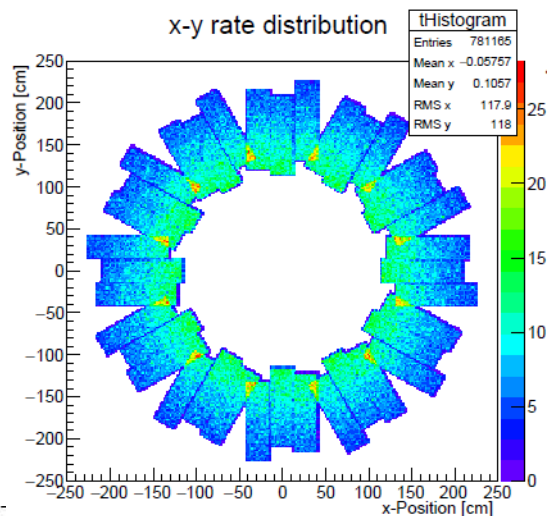

- Beam energy **4 AGeV**
- Interaction rate 10kHz (2kHz recording rate)
- Fix target position 4.8 m
- Particle flux $< 15\text{Hz/cm}^2$
- Multi-hit rate $< 3.4\%$



Ingo Deppner

CBM-STAR joint Workshop
Wuhan 23.09.2017

36



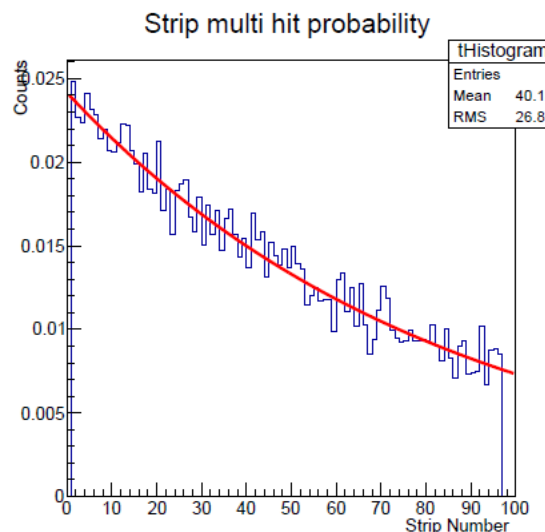
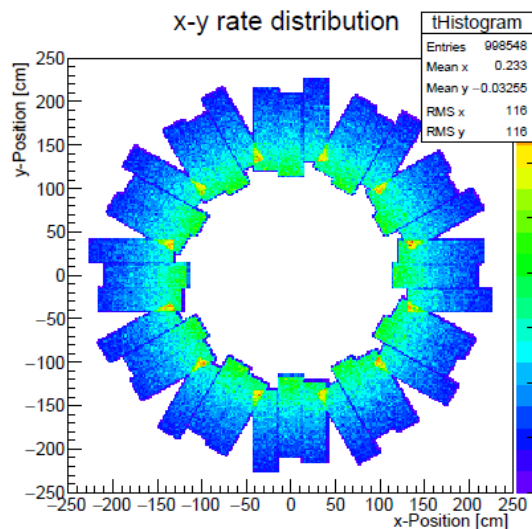

Primary particles

- Beam energy **10 AGeV**
- Particle flux $< 20 \text{ Hz/cm}^2$
- Multi-hit rate $< 2.4 \%$

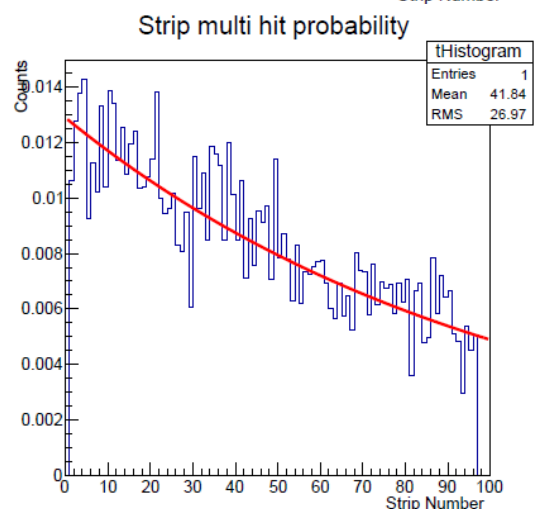
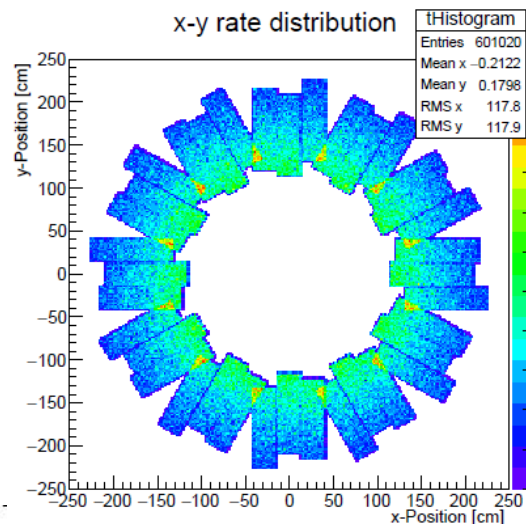

- Beam energy **4 AGeV**
- Particle flux $< 12 \text{ Hz/cm}^2$
- Multi-hit rate $< 1.3 \%$

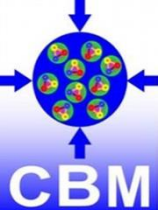

Summary on rate and multi-hit probability



Beam energy	4A GeV	10A GeV	25A GeV
Max. rate of all particles [Hz/cm ²]	15	30	45
Max multi-hit prob. of all part. [%]	3.4	5.8	7.4
Max rate of prim. particles [Hz/cm ²]	12	20	25
Max multi-hit prob. of prim. part [%]	1.3	2.4	3.6

